

UL Evaluation Report

UL ER25913-01

Issued: March 31, 2016

Revised: December 10, 2019

Visit UL,LLC's [Product iQ™ database](#) for status of Report.

UL Category Code: ULEZ

CSI MasterFormat®

DIVISION: 07 00 00 - THERMAL AND MOISTURE PROTECTION

Sub-level 2: 07 40 00 - Roofing and Siding Panels

Sub-level 3: 07 41 00 - Roof Panels

Sub-level 4: 07 41 13 - Metal Roof Panels

COMPANY:

TAYLOR METAL INC, DBA TAYLOR METAL PRODUCTS

4566 RIDGE DRIVE NE

SALEM, OR 97301-6992

(503) 581-8338

www.taylormetal.com

1. SUBJECT:

EASY LOCK, VERSA SPAN, MS 100, MS 150, MS 200, PREMIER-LOCK 100, PREMIER LOCK 150, CLIP-LOCK 150, AND T PANEL NARROW BATTEN METAL ROOFING PANELS

2. SCOPE OF EVALUATION:

- 2018, 2015, and 2012 *International Building Code*® (IBC)
- 2018, 2015, and 2012 *International Residential Code*® (IRC)
- 2019, 2016, and 2013 California Building Code
- 2019, 2016, and 2013 California Residential Code
- ICC-ES Acceptance Criteria for Quality Documentation (AC10)
- ICC-ES Acceptance Criteria for Metal Roof Coverings (AC166)

The products were evaluated for the following properties:

- Roofing Systems for Exterior Fire Exposure (ANSI/UL790, ASTM E108)
- Roof Deck Construction (ANSI/UL 580)
- Corrosion Resistance (ASTM A653, ASTM A792)
- Corrosion Resistance (ASTM B370)



3. REFERENCED DOCUMENTS

- ICC-ES:
 - ICC-ES Acceptance Criteria for Metal Roof Coverings (AC166), dated October 2012 (January 2018)
 - ICC-ES Acceptance Criteria for Quality Documentation (AC10), dated January 2019
- ANSI/UL:
 - ANSI/UL 580, Fifth Edition, Standard for Tests for Uplift Resistance of Roof Assemblies dated March 29, 2019
 - ANSI/UL790, Eighth Edition (ASTM E108-16), Standard Test Methods for Fire Tests of Roof Coverings dated October 19, 2018
- ASTM:
 - ASTM A653/A653M-15, *Standard Specification for Steel Sheet, Zinc-Coated (Galvanized) or Zinc-Iron Alloy-Coated (Galvannealed) by the Hot-Dip Process*
 - ASTM A792/A792M-10(2015), *Standard Specification for Steel Sheet, 55% Aluminum-Zinc Alloy-Coated by the Hot-Dip Process*
 - ASTM B370-12, *Standard Specification for Copper Sheet and Strip for Building Construction*
 - ASTM G154-12a, *Practice for Operating Xenon Arc Light Apparatus for Exposure of Nonmetallic Materials*

4. USES

Easy Lock, MS 200, Versa Span, MS 100, MS 150, Premier-Lock 100, Premier-Lock 150, Clip-Lock 150, and T Panel Narrow Batten metal roofing panels are used as roof covering materials in Class A roofing systems installed on roof decks having slopes 2:12 or greater, in accordance with this report, and the manufacturer's published installation instructions.

5. PRODUCT DESCRIPTION

Taylor Metal Products' metal roofing panels described in this report are either coated or painted metal formed from ASTM A653 G90, ASTM A792 AZ50 hot-dip coated sheet steel, or from ASTM B370 cold-rolled copper sheet.

Steel Easy Lock panels are manufactured to have a base metal thickness not less than 26 gauge [0.0179 in. (0.455 mm)]. Steel MS 100, MS 150, MS 200, Versa Span, Premier-Lock 100, Premier-Lock 150, Clip-Lock 150, and T Panel Narrow Batten panels are manufactured to have a base metal thickness not less than 25 gauge [0.0209 in. (0.531 mm)]. Copper Easy Lock, MS 100, MS 150, MS 200, Versa Span, Premier-Lock 100, Premier-Lock 150, and Clip-Lock 150 panels are manufactured to a finished weight not less than 16 ounces per square foot having a thickness of [0.0216 in. (0.549 mm)], with the allowable tolerances.

The panels are metal roof coverings complying with [Section 1507.4](#) of the 2018, 2015, and 2012 IBC, and 2019 California Building Code, [Section R905.10](#) of the 2018, 2015, and 2012 IRC, and California Residential Code.

Fire Certification: Taylor Metal Products' metal roofing panels covered under this report have been tested for Class A fire Certification in accordance with ANSI/UL790 (ASTM E108) and qualify for use under [Section 1505.1](#) of the 2018, 2015, and 2012 IBC, [Section R902.1](#) of the 2018, 2015, and 2012 IRC, and 2019 California Residential Code. Refer to [Table 1](#), [Table 2](#), [Table 3](#), and [Table 4](#). See the Listing under TGFU.R25913 which includes T-3, Tuff-Rib, PBR/Marion R, Classic ⅜ Corrugated, and HR 34 profiles.

Wind Resistance: Roofing assemblies shall be designed to resist the design wind load pressures for components and cladding in accordance with [Section 1609.5](#) and [Section 1504.3](#) of the 2018, 2015, and

2012 IBC, 2019 California Building Code, and [Section R905.1](#) of the 2018, 2012, and 2009 IRC, and 2019 California Residential Code.

Wind Uplift Resistance: Taylor Metal Products' metal roofing panels covered under this report have been tested for wind uplift resistance in accordance with ANSI/UL 580 complying with Section 1504.3.1 of the 2015 IBC and 2019 California Building Code, [Section 1504.3.2](#) of the 2012, and 2009 IBC. Refer to [Table 1](#), [Table 2](#), [Table 3](#), and [Table 4](#).

Wind-Driven Rain Resistance: The metal roofing panels covered under this report are not intended for installation in High-Velocity Hurricane Zones. Therefore, the wind-driven rain test specified in AC166 was not conducted under this evaluation.

Corrosion Resistance: Taylor metal roofing panels covered under this report comply with the performance requirements for metal panel roof coverings as outlined in [Section 1507.4.3](#) of the 2018, 2015, and 2012 IBC and 2019 California Building Code, [Section 905.10.3](#) of the 2018, 2015, and 2012 IRC and California Residential Code meet the requirements for resistance to corrosion in accordance with ASTM A792.

6. INSTALLATION

6.1 General

Taylor metal roofing panels must be installed in accordance with [Section 1507.4](#) of the 2018, 2015, and 2012 IBC, and 2019 California Building Code, or [Section R905.10](#) of the 2018, 2015, and 2012 IRC, and California Residential Code, except as noted in this report, and the manufacturer's published installation instructions. The manufacturer's published installation instructions must be available at all times on the jobsite during installation. The metal roofing panels must be attached to the decked sheathing in a manner that will secure the panels in place.

6.2 Slope

MS 100 and MS 150 metal roofing panels are not to be installed on roof decks having slopes less than 1:12. MS 200 metal roofing panels are not to be installed on roof decks having slopes less than ½:12. All other products covered in this report are intended for roof decks having 2:12 slope or greater. Installation of Taylor metal roofing panels covered in this report are to be installed in accordance with [Section 1507.4.2](#) of the 2018, 2015, and 2012 IBC, and the 2019 California Building Code or [Section R905.10.2](#) of the 2018, 2015, and 2012 IRC and the 2019 California Residential Code.

6.3 Roof Deck

Roof decking is to be as described in [Section 1507.4.1](#) of the 2018, 2015, and 2012 IBC, and the 2019 California Building Code, or [Section R905.10.1](#) of the 2018, 2015, and 2012 IRC and the 2019 California Residential Code. Roof deck must be code-compliant, minimum nominal ½ inch-thick (11.9 mm) exterior sheathing complying with [Section 2304.8.2](#) of the 2018 IBC, [Section 2304.7.2](#) of the 2015 and 2012 IBC and 2019 California Building Code, or [Section R803](#) of the 2018, 2015, and 2012 IRC and the 2019 California Residential Code, or minimum No. 22 gauge [0.030 inch thick (0.76 mm)] steel complying with Section [2210.1.1.2](#) of the 2018, 2015, and 2012 IBC, and the 2019 California Building Code. The sheathing must be structurally sound and adequately fastened to resist wind loads for components and cladding as specified in [Section 1609](#) of the 2018, 2015, and 2012 IBC, and 2019 California Building Code, or [Section R301.6](#) of the 2018, 2015, and 2012 IRC, and the 2019 California Residential Code.

6.4 Underlayment

An ice barrier must be installed along the eaves in locations historically prone to ice in accordance with [Section 1507.7.4](#) of the 2018, 2015, and 2012 IBC, and the 2019 California Building Code, the 2019 California Residential Code, or [Section R905.5.3.1](#) of the 2018, 2015, and 2012 IRC. In addition to the ice

barrier, an underlayment must be installed over the entire roof deck in accordance with [Section 1507.1.1](#) of the 2018, 2015, and 2012 IBC, and the 2019 California Building Code, and [Section R905.6.3](#) of the 2018, 2015, and 2012 IRC, and California Residential Code.

Underlayments installed on roofs in locations prone to high winds must be installed in accordance with [Section 1507.4.5](#) of the 2018, 2015, and 2012 IBC, and the 2019 California Building Code, or [Section R905.6.3](#) of the 2018, 2015, and 2012 IRC, and the 2019 California Residential Code.

6.5 Flashing

Flashing materials are to be installed in accordance with [Section 1503.2](#) of the 2018, 2015, and 2012 IBC, and the 2019 California Building Code, [Section R903.2](#) of the 2018, 2015, and 2012 IRC and the 2019 California Residential Code, as applicable.

6.6 Hips and Ridges

Hips and ridges must be installed in accordance with Taylor Metal, Inc.'s published installation instructions for exposure dimension and fastener type.

6.7 Fasteners and Attachment

Attachment of the roof panels must be in accordance with [Section 1507.4.4](#) of the 2018, 2015, and 2012 IBC, and the 2019 California Building Code.

6.8 Reroofing

Existing roof covering materials detrimental to performance of the roofing assembly are to be completely removed and replaced prior to installation of the Taylor metal roofing panels. Installation is to be performed for new construction as described in Section 6 of this report.

The existing roof shall be inspected in accordance with the provisions and limitations of [Section 1511](#) of the 2018 and 2015 IBC, [Section 1510](#) of the 2012 and 2009 IBC, and 2019 California Building Code, and [Section R908](#) of the 2018 and 2015 IRC, [Section R907](#) of the 2012 IRC, and California Residential Code, as applicable. Prior to the reroofing, hip and ridge coverings must be removed.

Flashing and edging must comply with Section 6.6 of this report and with [Section 1511.6](#) of the 2018 and 2015 IBC, [Sections 1510.5](#) and [1510.6](#) of the 2012 IBC and 2019 California Building Code, and [Section R908.6](#) of the 2018 and 2015 IRC, and [Section R907.6](#) of the 2012 IRC, and California Residential Code, as applicable.

Taylor Metal Products metal roof panels may be installed over existing Class A asphalt glass fiber mat shingles or any Class A UL Listed roof system as described in the UL Certification Category for Prepared Roof-covering Materials, Formed or Molded Metal, Fiber-Cement, Plastic or Fire-retardant-treated Wood (TFXX), for applicable coverage and details of the roof assembly.

7. CONDITIONS OF USE

The metal roofing panels described in this report comply with, or are suitable alternatives to, what is specified in those codes listed in Section 2 of this report, subject to the following conditions:

- 7.1** Materials and methods of installation must comply with this report and the manufacturer's published installation instructions. In the event of a conflict between the installation instructions and this report, this report governs.

- 7.2 Only Taylor specified fasteners shall be used in the installation of the roof covering system.
- 7.3 See UL's [Product iQ™ database](#) for Metal Roof Deck Panels ([TJPV](#)), Roofing Systems ([TGFU](#)), and Roof-covering Materials, Impact Resistance ([TGAM](#)), respectively.
- 7.4 Wind uplift pressures on any roof area, including edges and corner zones shall not exceed the allowable wind pressure for the roof covering installed in that particular area. The allowable wind uplift pressure for the roof assembly shall be based on a minimum factor of safety of 2.0 as shown in the Certification for uplift resistance (TGIK). The allowable wind uplift pressure is for the roof system only. The deck and framing to which the roofing system is attached shall be designed for the applicable components and cladding wind loads in accordance with the applicable code.
- 7.5 The metal roofing panels covered under this report are produced under the UL LLC Listing/Certification and Follow-Up Service Program, which includes audits in accordance with quality elements of ICC-ES Acceptance Criteria for Quality Documentation, AC10.

8. SUPPORTING EVIDENCE

- 8.1 Data in accordance with ICC-ES Acceptance Criteria for Metal Roof Coverings (AC166), dated October 2012.
- 8.2 Manufacturer's descriptive product literature, including installation instructions.
- 8.3 UL Certification reports in accordance with ANSI/UL 580, ANSI/UL 790, and UL 2218. See UL Product Certification Categories (TJPV), (TGFU), and (TGAM), File R25913.
- 8.4 Documentation of quality system elements described in ICC-ES Acceptance Criteria for Quality Documentation (AC10), dated January 2019.

9. IDENTIFICATION

Taylor metal roofing panels described in this evaluation report are identified by a marking bearing the report holder's name (Taylor, Inc.) and address, the product name, the UL Certification Mark, and the evaluation report number UL ER25913-01. The validity of the evaluation report is contingent upon this identification appearing on the product or UL Certification Mark certificate.

10. USE OF UL EVALUATION REPORT

- 10.1 The approval of building products, materials, or systems is the responsibility of the applicable authorities having jurisdiction.
- 10.2 UL Evaluation Reports shall not be used in any manner that implies an endorsement of the product, material or system by UL.
- 10.3 The status of this report, as well as a complete directory of UL Evaluation Reports may be found at UL.com via the [Product iQ™ database](#).

TABLE 1: UL 790 CLASS A¹ FIRE RATED WIND UPLIFT ASSEMBLIES

System Number	Combustible Deck		Barrier Product	Metal Panel ⁴ Attachment	Allowable Uplift Pressure ANSI/UL 580
	Wood Sheathing ²	Attachment ³			
Minimum 29 Gauge Steel Easy Lock⁵, Maximum 18 inches wide					Class 90
1	Minimum nominal $\frac{5}{8}$ inch APA Span-Rated plywood	Minimum #6 x 1- $\frac{7}{8}$ inch bugle head screws or #8d annular ring shank nails spaced 6 inches oc at board edge and 12 inches oc into framing members	Georgia Pacific $\frac{1}{4}$ inch minimum DensDeck board or $\frac{1}{4}$ inch minimum United States Gypsum Co SECUROCK Glass-Mat Roof Board (Type SGMRX), National Gypsum DEXcell Glass Mat Roof Board or DEXcell FV Glass Mat Roof Board, CertainTeed Gypsum GlasRoc or $\frac{1}{2}$ inch minimum UL Certified gypsum board with all joints staggered a minimum of 6 inches from the plywood joints, or one layer GAF-Elk VersaShield Underlayment or Firestone Building Products CLAD-GARD SA FR Underlayment	(1) Minimum No. 10 x 1 inch pancake head screws spaced 12 inches oc in slotted fastener flange	-52.5
Minimum 24 Gauge Steel Easy Lock⁵, Maximum 18 inches wide					Class 90
2	Minimum $\frac{19}{32}$ inch APA Span-Rated plywood	#6 x 1- $\frac{7}{8}$ inch bugle head screws or #8d annular ring shank nails spaced 6 inches oc at board edge and 12 inches oc into framing members ⁵	Georgia Pacific $\frac{1}{4}$ inch minimum DensDeck board or $\frac{1}{4}$ inch minimum United States Gypsum Co SECUROCK Glass-Mat Roof Board (Type SGMRX), National Gypsum DEXcell Glass Mat Roof Board or DEXcell FV Glass Mat Roof Board, CertainTeed Gypsum GlasRoc or $\frac{1}{2}$ inch minimum UL Certified gypsum board with all joints staggered a minimum of 6 inches from the plywood joints, or one layer GAF-Elk VersaShield Underlayment or Firestone Building Products CLAD-GARD SA FR Underlayment	(2) Minimum No. 10-12 x 1 inch pancake head screws spaced 36 inches oc	-52.5

¹Unlimited Slope

²All side and butt joints to be sealed with urethane caulk

³Structural members spaced maximum 24 inches oc

⁴Any UL Certified Type G1, G2 or G3 base or ply sheet, Type 15 or 30 felt or UL Certified prepared roofing accessory may be used directly underneath the metal roof cover

⁵Meets Class 4 Impact Rating

TABLE 1: UL 790 CLASS A¹ FIRE RATED WIND UPLIFT ASSEMBLIES

System Number	Combustible Deck		Barrier Product	Metal Panel ⁴ Attachment	Allowable Uplift Pressure ANSI/UL 580
	Wood Sheathing ²	Attachment ³			
Minimum 24 Gauge Steel Versa Span⁵, Maximum 18 inches wide					Class 90
3	Minimum ¹⁹ / ₃₂ inch APA Span-Rated plywood	Minimum #6 x 1- ⁷ / ₈ inch bugle head screws or #8d annular ring shank nails spaced 6 inches oc at board edge and 12 inches oc into framing members	Georgia Pacific ¹ / ₄ inch minimum DensDeck board or ¹ / ₄ inch minimum United States Gypsum Co SECUROCK Glass-Mat Roof Board (Type SGMRX), National Gypsum DEXcell Glass Mat Roof Board or DEXcell FV Glass Mat Roof Board, CertainTeed Gypsum GlasRoc or ¹ / ₂ inch minimum UL Certified gypsum board with all joints staggered a minimum of 6 inches from the plywood joints, or one layer GAF-Elk VersaShield Underlayment or Firestone Building Products CLAD-GARD SA FR Underlayment	(2) Minimum No. 10-12 x 1 inch pancake head screws spaced 36 inches oc	-52.5
4				(2) Minimum No. 10-12 x 1 inch pancake head screws spaced 36 inches oc	-52.5

¹Unlimited Slope

²All side and butt joints to be sealed with urethane caulk

³Structural members spaced maximum 24 inches oc

⁴Any UL Certified Type G1, G2 or G3 base or ply sheet, Type 15 or 30 felt or UL Certified prepared roofing accessory may be used directly underneath the metal roof cover

⁵Meets Class 4 Impact Rating

TABLE 1: UL 790 CLASS A¹ FIRE RATED WIND UPLIFT ASSEMBLIES (continued)

System Number	Combustible Deck		Barrier Product	Metal Panel ⁴ Attachment	Allowable Uplift Pressure ANSI/UL 580
	Wood Sheathing ²	Attachment ³			
Minimum .032 Aluminum Versa Span⁵, Maximum 16 inches wide					Class 90
5	Minimum ¹⁹ / ₃₂ inch APA Span-Rated plywood	No. 8 x 1- ⁷ / ₈ inch bugle head screws or #8d annular ring shank nails spaced 6 inches oc at board edge and 12 inches oc into framing members	Georgia Pacific ¹ / ₄ inch minimum DensDeck board or ¹ / ₄ inch minimum United States Gypsum Co SECUROCK Glass-Mat Roof Board (Type SGMRX), National Gypsum DEXcell Glass Mat Roof Board or DEXcell FV Glass Mat Roof Board, CertainTeed Gypsum GlasRoc or ¹ / ₂ inch minimum UL Certified gypsum board with all joints staggered a minimum of 6 inches from the plywood joints, or one layer GAF-Elk VersaShield Solo Underlayment or Firestone Building Products CLAD-GARD SA FR Underlayment	(2) Minimum No. 10-12 pancake head screws spaced 18 inches oc	-52.5
Minimum 24 Gauge Steel T-Panel Narrow Batten⁵, Maximum 21-¹/₄ inches wide					Class 90
6	Minimum ¹⁹ / ₃₂ inch APA Span-Rated plywood	No. 8 x 1- ⁷ / ₈ inch bugle head screws or #8d annular ring shank nails spaced 6 inches oc at board edge and 12 inches oc into framing members	Georgia Pacific ¹ / ₄ inch min DensDeck board or ¹ / ₄ inch min United States Gypsum Co SECUROCK Glass-Mat Roof Board (Type SGMRX), National Gypsum DEXcell Glass Mat Roof Board or DEXcell FV Glass Mat Roof Board, CertainTeed Gypsum GlasRoc or ¹ / ₂ inch min UL Certified gypsum board with all joints staggered a min of 6 in. from the plywood joints, or one layer GAF-Elk VersaShield Underlayment or Firestone Building Products CLAD-GARD SA FR Underlayment	(2) Minimum No. 10-12 x 1 inch pancake head screws spaced 36 inches oc	-52.5

¹Unlimited Slope

²All side and butt joints to be sealed with urethane caulk

³Structural members spaced maximum 24 inches oc

⁴Any UL Certified Type G1, G2 or G3 base or ply sheet, Type 15 or 30 felt or UL Certified prepared roofing accessory may be used directly underneath the metal roof cover

⁵Meets Class 4 Impact Rating

TABLE 1: UL 790 CLASS A¹ FIRE RATED WIND UPLIFT ASSEMBLIES (continued)

System Number	Combustible Deck		Barrier Product	Metal Panel ⁴ Attachment	Allowable Uplift Pressure ANSI/UL 580
	Wood Sheathing ²	Attachment ³			
Minimum 24 Gauge Steel T-Panel Narrow Batten⁵, Maximum 21-¼ inches wide					Class 90
7	Minimum ¹⁹ / ₃₂ inch APA Span-Rated plywood	No. 8 x 1- ⁷ / ₈ inch bugle head screws or #8d annular ring shank nails spaced 6 inches oc at board edge and 12 inches oc into framing members	Georgia Pacific ¼ inch min DensDeck board or ¼ inch min United States Gypsum Co SECUROCK Glass-Mat Roof Board (Type SGMRX), National Gypsum DEXcell Glass Mat Roof Board or DEXcell FV Glass Mat Roof Board, CertainTeed Gypsum GlasRoc or ½ inch min UL Certified gypsum board with all joints staggered a min of 6 in. from the plywood joints, or one layer GAF-Elk VersaShield Underlayment or Firestone Building Products CLAD-GARD SA FR Underlayment	(1) Minimum No. 10-12 x 1 inch pancake head screws spaced 24 inches oc	-52.5
Minimum 24 Gauge Steel T-Panel Narrow Batten⁵, Maximum 20 inches wide					Class 90
8	Minimum ¹⁹ / ₃₂ inch APA Span-Rated plywood	No. 8 x 1- ⁷ / ₈ inch bugle head screws or #8d annular ring shank nails spaced 6 inches oc at board edge and 12 inches oc into framing members	Georgia Pacific ¼ inch minimum DensDeck board or ¼ inch minimum United States Gypsum Co SECUROCK Glass-Mat Roof Board (Type SGMRX), National Gypsum DEXcell Glass Mat Roof Board or DEXcell FV Glass Mat Roof Board, CertainTeed Gypsum GlasRoc or ½ inch minimum UL Certified gypsum board with all joints staggered a minimum of 6 inches from the plywood joints, or one layer GAF-Elk VersaShield Underlayment or Firestone Building Products CLAD-GARD SA FR Underlayment	(2) Minimum No. 10-12 pancake head screws spaced 18 inches oc	-52.5

¹Unlimited Slope

²All side and butt joints to be sealed with urethane caulk

³Structural members spaced maximum 24 inches oc

⁴Any UL Certified Type G1, G2 or G3 base or ply sheet, Type 15 or 30 felt or UL Certified prepared roofing accessory may be used directly underneath the metal roof cover

⁵Meets Class 4 Impact Rating

TABLE 1: UL 790 CLASS A¹ FIRE RATED WIND UPLIFT ASSEMBLIES (continued)

System Number	Combustible Deck		Barrier Product	Metal Panel ⁴ Attachment	Allowable Uplift Pressure ANSI/UL 580
	Wood Sheathing ²	Attachment ³			
16 Oz. Copper MS 100⁵, Maximum 17 inches wide					Class 90
9	Minimum ¹⁹ / ₃₂ inch APA Span-Rated plywood	#6 x 1- ⁷ / ₈ inch bugle head screws or #8d annular ring shank nails spaced 6 inches oc at board edge and 12 inches oc into framing members	Georgia Pacific ¹ / ₄ inch minimum DensDeck board or ¹ / ₄ inch minimum United States Gypsum Co SECUROCK Glass-Mat Roof Board (Type SGMRX), National Gypsum DEXcell Glass Mat Roof Board or DEXcell FV Glass Mat Roof Board, CertainTeed Gypsum GlasRoc or ¹ / ₂ inch minimum UL Certified gypsum board with all joints staggered a minimum of 6 inches from the plywood joints, or one layer GAF-Elk VersaShield Solo Underlayment or Firestone Building Products CLAD-GARD SA FR Underlayment	(2) Minimum No. 10-12 x 1 inch pancake head screws spaced 18	-52.5
Minimum 24 Gauge Steel MS 100⁵, Maximum 18 inches wide					Class 90
10	Minimum nominal ⁵ / ₈ inch APA Span-Rated plywood	No. 8 x 2- ¹ / ₂ inch bugle head screws or #8d annular ring shank nails spaced 6 inches oc at board edge and 12 inches oc into framing members	Georgia Pacific ¹ / ₄ inch minimum DensDeck board or ¹ / ₄ inch minimum United States Gypsum Co SECUROCK Glass-Mat Roof Board (Type SGMRX), National Gypsum DEXcell Glass Mat Roof Board or DEXcell FV Glass Mat Roof Board, CertainTeed Gypsum GlasRoc or ¹ / ₂ inch minimum UL Certified gypsum board with all joints staggered a minimum of 6 inches from the plywood joints, or one layer GAF-Elk VersaShield Underlayment or Firestone Building Products CLAD-GARD SA FR Underlayment	(2) Minimum No. 10-12 x 1 inch pancake head screws spaced 24	-52.5

¹Unlimited Slope

²All side and butt joints to be sealed with urethane caulk

³Structural members spaced maximum 24 inches oc

⁴Any UL Certified Type G1, G2 or G3 base or ply sheet, Type 15 or 30 felt or UL Certified prepared roofing accessory may be used directly underneath the metal roof cover

⁵Meets Class 4 Impact Rating

TABLE 1: UL 790 CLASS A¹ FIRE RATED WIND UPLIFT ASSEMBLIES (continued)

System Number	Combustible Deck		Barrier Product	Metal Panel ⁴ Attachment	Allowable Uplift Pressure ANSI/UL 580
	Wood Sheathing ²	Attachment ³			
Minimum 24 Gauge Steel MS 150⁵, Maximum 16 inches wide					Class 90
11	Minimum nominal ½ inch APA Span-Rated plywood	#7-6 x 1- ⁵ / ₈ inch bugle head screws or #8d annular ring shank nails spaced 6 inches oc at board edge and 12 inches oc into framing members ⁵	Georgia Pacific ¼ inch minimum DensDeck board or ¼ inch minimum United States Gypsum Co SECUROCK Glass-Mat Roof Board (Type SGMRX), National Gypsum DEXcell Glass Mat Roof Board or DEXcell FV Glass Mat Roof Board, CertainTeed Gypsum GlasRoc or ½ inch minimum UL Certified gypsum board with all joints staggered a min of 6 in. from the plywood joints, or one layer GAF-Elk VersaShield Underlayment or Firestone Building Products CLAD-GARD SA FR Underlayment	(4) Minimum No. 10-12 x 1 inch pancake head screws spaced 48 inches oc	-52.5
12	Minimum nominal 5/8 inch APA Span-Rated plywood	No. 8 x 2-½ inch bugle head screws spaced 6 inches oc at board edge and 12 inches oc into framing members	Georgia Pacific ¼ inch minimum DensDeck board or ¼ inch minimum United States Gypsum Co SECUROCK Glass-Mat Roof Board (Type SGMRX), National Gypsum DEXcell Glass Mat Roof Board or DEXcell FV Glass Mat Roof Board, CertainTeed Gypsum GlasRoc or ½ inch minimum UL Certified gypsum board with all joints staggered a min of 6 in. from the plywood joints, or one layer GAF-Elk VersaShield Underlayment or Firestone Building Products CLAD-GARD SA FR Underlayment	(2) Minimum ¼-13 x 1- ⁵ / ₈ inch truss head screws spaced 36 inches oc	-52.5

¹Unlimited Slope

²All side and butt joints to be sealed with urethane caulk

³Structural members spaced maximum 24 inches oc

⁴Any UL Certified Type G1, G2 or G3 base or ply sheet, Type 15 or 30 felt or UL Certified prepared roofing accessory may be used directly underneath the metal roof cover

⁵Meets Class 4 Impact Rating

TABLE 1: UL 790 CLASS A¹ FIRE RATED WIND UPLIFT ASSEMBLIES (continued)

System Number	Combustible Deck		Barrier Product	Metal Panel ⁴ Attachment	Allowable Uplift Pressure ANSI/UL 580
	Wood Sheathing ²	Attachment ³			
Minimum .032 Aluminum MS 150⁵, Maximum 20 inches wide					Class 90
13	Minimum nominal 5/8 inch APA Span-Rated plywood	No. 8 x 2-1/2 inch bugle head screws spaced 6 inches oc at board edge and 12 inches oc into framing members	Georgia Pacific 1/4 inch minimum DensDeck board or 1/4 inch minimum United States Gypsum Co SECUROCK Glass-Mat Roof Board (Type SGMRX), National Gypsum DEXcell Glass Mat Roof Board or DEXcell FV Glass Mat Roof Board, CertainTeed Gypsum GlasRoc or 1/2 inch minimum UL Certified gypsum board with all joints staggered a minimum of 6 inches from the plywood joints, or one layer GAF-Elk VersaShield Solo Underlayment or Firestone Building Products CLAD-GARD SA FR Underlayment	(2) Minimum 1/4-13 x 1-5/8 inch truss head screws spaced 36 inches oc	-52.5
Minimum .032 Zinc MS 150⁵, Maximum 16 inches wide					Class 90
14	Minimum nominal 5/8 inch APA Span-Rated plywood	No. 8 x 2-1/2 inch bugle head screws spaced 6 inches oc at board edge and 12 inches oc into framing members	Georgia Pacific 1/4 inch minimum DensDeck board or 1/4 inch minimum United States Gypsum Co SECUROCK Glass-Mat Roof Board (Type SGMRX), National Gypsum DEXcell Glass Mat Roof Board or DEXcell FV Glass Mat Roof Board, CertainTeed Gypsum GlasRoc or 1/2 inch minimum UL Certified gypsum board with all joints staggered a min of 6 in. from the plywood joints, or one layer GAF-Elk VersaShield Solo Underlayment or Firestone Building Products CLAD-GARD SA FR Underlayment	(2) Minimum 1/4-13 x 1-5/8 inch truss head screws spaced 36 inches oc	-52.5

¹Unlimited Slope

²All side and butt joints to be sealed with urethane caulk

³Structural members spaced maximum 24 inches oc

⁴Any UL Certified Type G1, G2 or G3 base or ply sheet, Type 15 or 30 felt or UL Certified prepared roofing accessory may be used directly underneath the metal roof cover

⁵Meets Class 4 Impact Rating

TABLE 1: UL 790 CLASS A¹ FIRE RATED WIND UPLIFT ASSEMBLIES (continued)

System Number	Combustible Deck		Barrier Product	Metal Panel ⁴ Attachment	Allowable Uplift Pressure ANSI/UL 580
	Wood Sheathing ²	Attachment ³			
Minimum 24 Gauge Steel Premier-Lock 100⁵, Maximum 16 inches wide					Class 90
15	Minimum nominal 5/8 inch APA Span-Rated plywood	No. 8 x 2-1/2 inch bugle head screws or #8d annular ring shank nails spaced 6 inches oc at board edge and 12 inches oc into framing members ⁵	Georgia Pacific 1/4 in. min DensDeck board or 1/4 inch minimum United States Gypsum Co SECUROCK Glass-Mat Roof Board (Type SGMRX), National Gypsum DEXcell Glass Mat Roof Board or DEXcell FV Glass Mat Roof Board, CertainTeed Gypsum GlasRoc or 1/2 inch minimum UL Certified gypsum board with all joints staggered a min of 6 in. from the plywood joints, or one layer GAF-Elk VersaShield Underlayment or Firestone Building Products CLAD-GARD SA FR Underlayment	(1) Minimum No. 10-12 x 1 inch pancake head screws spaced 16 inches oc	-52.5
16 oz. Copper MS 150⁵, Maximum 16 inches wide					Class 90
16	Minimum nominal 5/8 inch APA Span-Rated plywood	No. 8 x 2-1/2 inch bugle head screws spaced 6 inches oc at board edge and 12 inches oc into framing members ⁵	Georgia Pacific 1/4 inch minimum DensDeck board or 1/4 inch minimum United States Gypsum Co SECUROCK Glass-Mat Roof Board (Type SGMRX), National Gypsum DEXcell Glass Mat Roof Board or DEXcell FV Glass Mat Roof Board, CertainTeed Gypsum GlasRoc or 1/2 inch minimum UL Certified gypsum board with all joints staggered a min of 6 in. from the plywood joints, or one layer GAF-Elk VersaShield Solo Underlayment or Firestone Building Products CLAD-GARD SA FR Underlayment	(2) Minimum 1/4-13 x 1-5/8 inch truss head screws spaced 36 inches oc	-52.5

¹Unlimited Slope

²All side and butt joints to be sealed with urethane caulk

³Structural members spaced maximum 24 inches oc

⁴Any UL Certified Type G1, G2 or G3 base or ply sheet, Type 15 or 30 felt or UL Certified prepared roofing accessory may be used directly underneath the metal roof cover

⁵Meets Class 4 Impact Rating

TABLE 1: UL 790 CLASS A¹ FIRE RATED WIND UPLIFT ASSEMBLIES (continued)

System Number	Combustible Deck		Barrier Product Configuration	Metal Panel ⁴ Attachment	Allowable Uplift Pressure ANSI/UL 580
	Wood Sheathing ²	Attachment ³			
Minimum 24 Gauge Steel Premier-Lock 150⁵, Maximum 14-½ inches wide					Class 90
17	Minimum nominal 5/8 inch APA Span-Rated plywood	No. 8 x 2-½ inch bugle head screws or #8d annular ring shank nails spaced 6 inches oc at board edge and 12 inches oc into framing members	Georgia Pacific ¼ inch minimum DensDeck board or ¼ inch minimum United States Gypsum Co SECUROCK Glass-Mat Roof Board (Type SGMRX), National Gypsum DEXcell Glass Mat Roof Board or DEXcell FV Glass Mat Roof Board, CertainTeed Gypsum GlasRoc or ½ inch minimum UL Certified gypsum board with all joints staggered a min of 6 in. from the plywood joints, or one layer GAF-EIk VersaShield Underlayment or Firestone Building Products CLAD-GARD SA FR Underlayment	(4) Minimum No. 10-12 x 1 inch pancake head screws spaced 18 inches oc	-52.5
Minimum 22 Gauge Steel Premier-Lock 150⁵, Maximum 16-¼ inches wide					Class 90
18	Minimum nominal 5/8 inch thick APA Span-Rated plywood	No. 8 x 2-½ inch bugle head screws or #8d annular ring shank nails spaced 6 inches oc at board edge and 12 inches oc into framing members	Georgia Pacific ¼ inch minimum DensDeck board or ¼ inch minimum United States Gypsum Co SECUROCK Glass-Mat Roof Board (Type SGMRX), National Gypsum DEXcell Glass Mat Roof Board or DEXcell FV Glass Mat Roof Board, CertainTeed Gypsum GlasRoc or ½ inch minimum UL Certified gypsum board with all joints staggered a min of 6 in. from the plywood joints, or one layer GAF-EIk VersaShield Underlayment or Firestone Building Products CLAD-GARD SA FR Underlayment	(1) Minimum No. 10 x 1 inch pancake head screws spaced 20-¾ inches oc	-52.5

¹Unlimited Slope

²All side and butt joints to be sealed with urethane caulk

³Structural members spaced maximum 24 inches oc

⁴Any UL Certified Type G1, G2 or G3 base or ply sheet, Type 15 or 30 felt or UL Certified prepared roofing accessory may be used directly underneath the metal roof cover

⁵Meets Class 4 Impact Rating

TABLE 1: UL 790 CLASS A¹ FIRE RATED WIND UPLIFT ASSEMBLIES (continued)

System Number	Combustible Deck		Barrier Product Configuration ⁵	Metal Panel ⁴ Attachment	Allowable Uplift Pressure ANSI/UL 580
	Wood Sheathing ²	Attachment ³			
Minimum 24 Gauge Steel Clip-Lock 150⁵, Maximum 16 inches wide					Class 90
19	Minimum nominal 5/8 inch thick APA Span-Rated plywood	No. 8 x 2-1/2 inch bugle head screws or #8d annular ring shank nails spaced 6 inches oc at board edge and 12 inches oc into framing members	Georgia Pacific 1/4 inch minimum DensDeck board or 1/4 inch minimum United States Gypsum Co SECUROCK Glass-Mat Roof Board (Type SGMRX), National Gypsum DEXcell Glass Mat Roof Board or DEXcell FV Glass Mat Roof Board, CertainTeed Gypsum GlasRoc or 1/2 inch minimum UL Certified gypsum board with all joints staggered a min of 6 in. from the plywood joints, or one layer GAF-Eik VersaShield Underlayment or Firestone Building Products CLAD-GARD SA FR Underlayment	(2) Minimum No. 10-12 x 1 inch pancake head screws spaced 36 inches oc	-52.5
20	Minimum nominal 1/2 inch thick APA Span-Rated plywood	No. 7-6 coarse thread, No. 1 Phillips drive, bugle-head, coated steel wood screws.	Georgia Pacific 1/4 inch minimum DensDeck board or 1/4 inch minimum United States Gypsum Co SECUROCK Glass-Mat Roof Board (Type SGMRX), National Gypsum DEXcell Glass Mat Roof Board or DEXcell FV Glass Mat Roof Board, CertainTeed Gypsum GlasRoc or 1/2 inch minimum UL Certified gypsum board with all joints staggered a min of 6 in. from the plywood joints, or one layer GAF-Eik VersaShield Underlayment or Firestone Building Products CLAD-GARD SA FR Underlayment	(2) Minimum No. 10-12 x 1 inch pancake head screws spaced 36 inches oc	-52.5

¹Unlimited Slope

²All side and butt joints to be sealed with urethane caulk

³Structural members spaced maximum 24 inches oc

⁴Any UL Certified Type G1, G2 or G3 base or ply sheet, Type 15 or 30 felt or UL Certified prepared roofing accessory may be used directly underneath the metal roof cover

⁵Meets Class 4 Impact Rating

TABLE 1: UL 790 CLASS A¹ FIRE RATED WIND UPLIFT ASSEMBLIES (continued)

System Number	Combustible Deck		Barrier Product Configuration	Metal Panel ⁴ Attachment	Allowable Uplift Pressure ANSI/UL 580
	Wood Sheathing ²	Attachment ³			
Minimum 24 Gauge Steel MS 200^{5,6}, Maximum 16 inches wide					Class 90
21	Minimum nominal 5/8 inch thick APA Span-Rated plywood or OSB	No. 8 x 1-7/8 inch bugle head screws or #8d annular ring shank nails spaced 6 inches oc at board edge and 12 inches oc into framing members	Georgia Pacific 1/4 inch minimum DensDeck board or 1/4 inch minimum United States Gypsum Co SECUROCK Glass-Mat Roof Board (Type SGMRX), National Gypsum DEXcell Glass Mat Roof Board or DEXcell FV Glass Mat Roof Board, CertainTeed Gypsum GlasRoc or 1/2 inch minimum UL Certified gypsum board with all joints staggered a min of 6 in. from the plywood joints, or one layer GAF-EIK VersaShield Underlayment or Firestone Building Products CLAD-GARD SA FR Underlayment	(2) Minimum No. 10-12 x 1 inch pancake head screws spaced 60 inches oc	-52.5
Minimum 24 Gauge Steel MS 200^{5,6}, Maximum 16 inches wide					Class 90
22	Minimum nominal 5/8 inch thick APA Span-Rated plywood	No. 8 x 1-7/8 inch bugle head screws or #8d annular ring shank nails spaced 6 inches oc at board edge and 12 inches oc into framing members	Georgia Pacific 1/4 inch minimum DensDeck board or 1/4 inch minimum United States Gypsum Co SECUROCK Glass-Mat Roof Board (Type SGMRX), National Gypsum DEXcell Glass Mat Roof Board or DEXcell FV Glass Mat Roof Board, CertainTeed Gypsum GlasRoc or 1/2 inch minimum UL Certified gypsum board with all joints staggered a min of 6 in. from the plywood joints, or one layer GAF-EIK VersaShield Underlayment or Firestone Building Products CLAD-GARD SA FR Underlayment	(2) Minimum No. 12-8 flat head screws spaced 30 inches oc	-52.5

¹Unlimited Slope

²All side and butt joints to be sealed with urethane caulk

³Structural members spaced maximum 24 inches oc

⁴Any UL Certified Type G1, G2 or G3 base or ply sheet, Type 15 or 30 felt or UL Certified prepared roofing accessory may be used directly underneath the metal roof cover

⁵Meets Class 4 Impact Rating

⁶Panel side laps may be rolled to 90° or 180°

TABLE 1: UL 790 CLASS A¹ FIRE RATED WIND UPLIFT ASSEMBLIES (continued)

System Number	Combustible Deck		Barrier Product Configuration	Metal Panel ⁴ Attachment	Allowable Uplift Pressure ANSI/UL 580
	Wood Sheathing ²	Attachment ³			
Minimum 24 Gauge Steel MS 200^{5,6}, Maximum 16 inches wide					Class 90
23	Minimum nominal 2 inch thick dimensional lumber planks	No. 8 x 1-7/8 inch bugle head screws or #8d annular ring shank nails	Georgia Pacific 1/4 inch minimum DensDeck board or 1/4 inch minimum United States Gypsum Co SECUROCK Glass-Mat Roof Board (Type SGMRX), National Gypsum DEXcell Glass Mat Roof Board or DEXcell FV Glass Mat Roof Board, CertainTeed Gypsum GlasRoc or 1/2 inch minimum UL Certified gypsum board with all joints staggered a min of 6 in. from the plywood joints, or one layer GAF-EIK VersaShield Underlayment or Firestone Building Products CLAD-GARD SA FR Underlayment	(2) No. 14 pancake head screws spaced 24 inches oc	-52.5
Minimum 24 Gauge Steel MS 200^{5,6}, Maximum 16 inches wide					Class 90
24	Minimum nominal 5/8 inch thick APA Span-Rated plywood or minimum nominal 2 inch thick dimensional lumber planks	No. 8 x 1-7/8 inch bugle head screws or #8d annular ring shank nails spaced 6 inches oc at board edge and 12 inches oc into framing members	Georgia Pacific 1/4 inch minimum DensDeck board or 1/4 inch minimum United States Gypsum Co SECUROCK Glass-Mat Roof Board (Type SGMRX), National Gypsum DEXcell Glass Mat Roof Board or DEXcell FV Glass Mat Roof Board, CertainTeed Gypsum GlasRoc or 1/2 inch minimum UL Certified gypsum board with all joints staggered a min of 6 in. from the plywood joints, or one layer GAF-EIK VersaShield Underlayment or Firestone Building Products CLAD-GARD SA FR Underlayment	(2) Minimum No. 10-12 x 1 inch pancake head screws spaced 36 inches oc	-52.5

¹Unlimited Slope

²All side and butt joints to be sealed with urethane caulk

³Structural members spaced maximum 24 inches oc

⁴Any UL Certified Type G1, G2 or G3 base or ply sheet, Type 15 or 30 felt or UL Certified prepared roofing accessory may be used directly underneath the metal roof cover

⁵Meets Class 4 Impact Rating

⁶Panel side laps may be rolled to 90° or 180°

TABLE 2: UL 790 CLASS A¹ FIRE RATED WIND UPLIFT ASSEMBLIES

System Number	Noncombustible Deck	Insulation ²	Coverboard or Barrier Product	Ply Sheet	Metal Panel Attachment	Allowable Uplift Pressure ANSI/UL 580
	Steel Decking					
Minimum 24 Gauge Steel MS 200³, Maximum 16 inches wide						Class 90
25	Minimum 22 MSG, 33 ksi steel ⁴	Any UL Listed Polyisocyanurate glass fiber, perlite or wood fiber, any thickness ⁵	Minimum ½ inch thick tongue and groove UL Certified gypsum board, butt end joints staggered over top flutes of steel deck.	Any UL Certified Type G1, G2 or G3 base or ply sheet, Type 15 or 30 felt or UL Certified prepared roofing accessory	(1) No. 18 hex washer head screws spaced 48 inches oc or (2) No. 14 truss head screws spaced 20 inches oc ⁶	-52.5
Minimum 24 Gauge Steel MS 200^{3,7}, Maximum 16 inches wide						Class 90
26	Minimum 22 MSG, 33 ksi steel ⁴	Any UL Listed Polyisocyanurate glass fiber, perlite or wood fiber, any thickness ⁵	See TGIK Listing for optional components.	Any UL Certified Type G1, G2 or G3 base or ply sheet, Type 15 or 30 felt or UL Certified prepared roofing accessory	(1) No. 11 hex washer head screws spaced 30 inches oc	-52.5
Minimum 24 Gauge Steel MS 200³, Maximum 16 inches wide						Class 90
27	Minimum 22 MSG, 33 ksi steel ⁸	Any UL Listed Polyisocyanurate glass fiber, perlite or wood fiber, any thickness ⁵	See TGIK Listing for optional components.	Any UL Certified Type G1, G2 or G3 base or ply sheet, Type 15 or 30 felt or UL Certified prepared roofing accessory	(2) No. 14 truss head screws spaced 48 inches oc	-52.5

¹Unlimited Slope

²6 mil vapor barrier may be used between steel deck and foam plastic insulation

³Meets Class 4 Impact Rating

⁴Structural supports spaced maximum 60 inches oc

⁵Fasteners used to attach insulation layer to steel deck to be minimum No. 11-13 truss head screws and penetrate steel deck by minimum ½ inch

⁶Insulation bearing plate not required if coverboard is used

⁷Panel side laps may be rolled to 90° or 180°

⁸Structural supports spaced maximum 72 inches oc

TABLE 2: UL 790 CLASS A¹ FIRE RATED WIND UPLIFT ASSEMBLIES (continued)

System Number	Noncombustible Deck	Insulation ²	Coverboard or Barrier Product	Ply Sheet	Metal Panel Attachment	Allowable Uplift Pressure ANSI/UL 580
	Steel Decking					
Minimum 24 Gauge Steel MS 200³, Maximum 16 inches wide						Class 90
28	Minimum 22 MSG, 33 ksi steel ⁴	Any UL Listed Polyisocyanurate glass fiber, perlite or wood fiber, any thickness ⁵	See TGIK Listing for components.	Any UL Certified Type G1, G2 or G3 base or ply sheet, Type 15 or 30 felt or UL Certified prepared roofing accessory	(2) No. 14 truss head screws spaced 20 inches oc, or (1) with continuous clip fastened 8 inches oc	-52.5
Minimum 24 Gauge Steel T-Panel Narrow Batten⁵, Maximum 21-¼ inches wide						Class 90
29	Minimum 22 MSG, 33 ksi steel	Any UL Listed Polyisocyanurate glass fiber, perlite or wood fiber, any thickness ⁵	Minimum 2.00 pcf extruded polystyrene foamed plastic insulation boards, maximum 4 inches thick.	Any UL Certified Type G1, G2 or G3 base or ply sheet, Type 15 or 30 felt or UL Certified prepared roofing accessory	(1) Minimum No. No. 14 truss head screws spaced 20 inches oc spaced 24 inches oc	-52.5

¹Unlimited Slope

²6 mil vapor barrier may be used between steel deck and foam plastic insulation

³Meets Class 4 Impact Rating

⁴Structural supports spaced maximum 60 inches oc

⁵Fasteners used to attach insulation layer to steel deck to be minimum No. 11-13 truss head screws and penetrate steel deck by minimum ½ inch

⁶Insulation bearing plate not required if coverboard is used

TABLE 2: UL 790 CLASS A¹ FIRE RATED WIND UPLIFT ASSEMBLIES (continued)

System Number	Noncombustible Deck	Insulation ³	Coverboard or Barrier Product	Ply Sheet	Metal Panel Attachment	Allowable Uplift Pressure ANSI/UL 580
	Steel Decking ²					
Minimum 24 Gauge Steel MS 200^{4,8}, Maximum 16 inches wide						Class 90
30	Minimum 22 MSG steel ⁵	Maximum 4 inch thick, any UL Listed rigid foam insulation, minimum 2.25 pcf density	Optional-Min ¹⁵ / ₃₂ inch plywood, or min ⁷ / ₁₆ inch thick OSB, ½ inch thick gypsum board, ½ inch wood fiberboard, ¼ inch min. thickness G-P Gypsum DensDeck, ¼ inch min thick USG SECUROCK Glass Mat Board or SECUROCK Roof Board applied over steel deck in lieu of Foamed Plastic or over Foamed Plastic ⁶	Any UL Certified Type G1, G2 or G3 base or ply sheet, Type 15 or 30 felt or UL Certified prepared	(1) No. 12 washered hex-head self drilling steel screw maximum 24 inches oc ⁷ with continuous clip	-52.5
Minimum 24 Gauge Steel MS 200^{4,8}, Maximum 18 inches wide						Class 90
31	Minimum 22 MSG steel ⁹	Any UL Listed Polyisocyanurate glass fiber, perlite or wood fiber, any thickness	Optional-Min ¹⁵ / ₃₂ inch plywood, or min ⁷ / ₁₆ inch thick OSB, ½ inch thick gypsum board, ½ inch wood fiberboard, ¼ inch min. thickness G-P Gypsum DensDeck, ¼ inch min thick USG SECUROCK Glass Mat Board or SECUROCK Roof Board applied over steel deck in lieu of Foamed Plastic or over Foamed Plastic ⁶	Any UL Certified Type G1, G2 or G3 base or ply sheet, Type 15 or 30 felt or UL Certified prepared roofing accessory	(2) No. 12 washered hex-head self drilling steel screw maximum 48 inches oc ⁷	-52.5

¹Unlimited Slope

²Minimum 33 ksi

³6 mil vapor barrier may be used between steel deck and foam plastic insulation

⁴Meets Class 4 Impact Rating

⁵Structural supports spaced maximum 48 inches oc

⁶Fasteners used to attach insulation layer to steel deck to be minimum No. 11-13 truss head screws and penetrate steel deck by minimum ½ inch

⁷Insulation bearing plate not required if coverboard is used

⁸Panel side laps may be rolled to 90° or 180°

⁹Structural supports spaced maximum 60 inches oc

TABLE 2: UL 790 CLASS A¹ FIRE RATED WIND UPLIFT ASSEMBLIES (continued)

System Number	Noncombustible Deck	Insulation ³	Coverboard or Barrier Product	Ply Sheet	Metal Panel Attachment	Allowable Uplift Pressure ANSI/UL 580
	Steel Decking ²					
Minimum 24 Gauge Steel MS 200^{4, 5}, Maximum 18 inches wide						Class 90
32	Minimum 22 MSG steel ⁶	Any UL Listed Polyisocyanurate glass fiber, perlite or wood fiber, any thickness	Optional-Min ^{15/32} inch plywood, or min ^{7/16} inch thick OSB, ½ inch thick gypsum board, ½ inch wood fiberboard, ¼ inch min. thickness G-P Gypsum DensDeck, ¼ inch min thick USG SECUROCK Glass Mat Board or SECUROCK Roof Board applied over steel deck in lieu of Foamed Plastic or over Foamed Plastic ⁷	Any UL Certified Type G1, G2 or G3 base or ply sheet, Type 15 or 30 felt or UL Certified prepared roofing accessory	(2) No. 14 truss head screws spaced 48 inches oc through NC3300, NCF-3300, NCF-3300-SS Series Clip with bearing plate ⁸	-52.5
Minimum 24 Gauge Steel Versa Span⁴, Maximum 18 inches wide						Class 90
33	Minimum 22 MSG steel ⁶	Any UL Listed Polyisocyanurate glass fiber, perlite or wood fiber, any thickness, or 5 inch composite structural fiber cement with foam plastic core	Optional-Min ^{15/32} inch plywood, or min ^{7/16} inch thick OSB, ½ inch thick gypsum board, ½ inch wood fiberboard, ¼ inch min. thickness G-P Gypsum DensDeck, ¼ inch min thick USG SECUROCK Glass Mat Board or SECUROCK Roof Board applied over steel deck in lieu of Foamed Plastic or over Foamed Plastic ⁷	Any UL Certified Type G1, G2 or G3 base or ply sheet, Type 15 or 30 felt or UL Certified prepared roofing accessory	(2) Minimum No. 10-16 x 1 inch pancake head screws or (2) No. 14 truss head screws spaced 48 inches oc Clip with bearing plate ⁸	-52.5

¹Unlimited Slope

²Minimum 33 ksi

³6 mil vapor barrier may be used between steel deck and foam plastic insulation

⁴Meets Class 4 Impact Rating

⁵Structural supports spaced maximum 48 inches oc

⁶Structural supports spaced maximum 60 inches oc

⁷Fasteners used to attach insulation layer to steel deck to be minimum No. 11-13 truss head screws and penetrate steel deck minimum ½ inch

⁸Insulation bearing plate not required if coverboard is used

TABLE 2: UL 790 CLASS A¹ FIRE RATED WIND UPLIFT ASSEMBLIES (continued)

System Number	Noncombustible Deck	Insulation	Coverboard or Barrier Product	Ply Sheet	Metal Panel Attachment	Allowable Uplift Pressure ANSI/UL 580
	Steel Decking ²					
24 Gauge Steel Versa Span³, Maximum 18 inches wide						Class 90
34	Minimum 22 MSG steel ⁴	Any UL Listed Polyisocyanurate glass fiber, perlite or wood fiber, any thickness, or 5 inch composite structural fiber cement with foam plastic core	Minimum 7/16 inch thick APA rated OSB ⁵	Any UL Certified Type G1, G2 or G3 base or ply sheet, Type 15 or 30 felt or UL Certified prepared roofing accessory	(2) No. 10-12 hex washer head screws spaced 36 inches oc in NC3300, NCF-3300, NCF-3300-SS Series Clip ⁶	-52.5
Minimum .032 Aluminum Versa Span⁴, Maximum 16 inches wide						Class 90
35	Minimum 22 MSG steel ⁴	Optional-Any UL Listed Polyisocyanurate glass fiber, perlite or wood fiber, any thickness, or 5 inch composite structural fiber cement with foam plastic core	Optional-Min 15/32 inch plywood, or min 7/16 inch thick OSB, 1/2 inch thick gypsum board, 1/2 inch wood fiberboard, 1/4 inch min. thickness G-P Gypsum DensDeck, 1/4 inch min thick USG SECUROCK Glass Mat Board or SECUROCK Roof Board applied over steel deck in lieu of Foamed Plastic or over Foamed Plastic ⁵	Any UL Certified Type G1, G2 or G3 base or ply sheet, Type 15 or 30 felt or UL Certified prepared roofing accessory	(2) No. 14 truss head screws spaced 18 inches oc through NC3300, NCF-3300, NCF-3300-SS Series Clip with bearing plate ⁶	-52.5

¹Unlimited Slope

²Minimum 33 ksi

³Meets Class 4 Impact Rating

⁴6 mil vapor barrier may be used between steel deck and foam plastic insulation

⁵Fasteners used to attach insulation layer to steel deck to be minimum No. 11-13 truss head screws and penetrate steel deck minimum 1/2-inch

⁶Insulation bearing plate not required if coverboard is used

TABLE 3: UL 790 CLASS A¹ FIRE RATED WIND UPLIFT ASSEMBLIES²

System Number	Insulation	Metal Panel Attachment	Allowable Uplift Pressure ANSI/UL 580
Minimum 24 Gauge Steel MS 200³, Maximum 18 inches wide			Class 90
36	Optional- Any compressible blanket insulation 8 in. max thick before compression, or 6 in. max thick when located between supports ⁴	(2) Minimum ¼-14 x 1 inch truss head screws	-52.5
Minimum 24 Gauge Steel MS 200³, Maximum 16 inches wide			Class 90
37	Optional- Any compressible blanket insulation 8 in. max thick before compression, or 6 in. max thick when located between supports ⁴	(2) Minimum ¼-14 x 1 inch truss head screws	-52.5
38	Optional- Any compressible blanket insulation 8 in. max thick before compression, or 6 in. max thick when located between supports ⁵	(2) No. 12 x 1 hex washer head screw when continuous or non-continuous clip is used	-52.5
Minimum 24 Gauge Steel Versa Span³, Maximum 12 inches wide			Class 90
39	Optional- Any UL Listed rigid roofing insulation board; Any compressible blanket insulation 8 in. max thick before compression, or 6 in. max thick when located between supports ⁴	(2) Minimum No. 10-16 x 1 inch pancake head screws or No. 14-13 DPI carbon, pancake head screw when rigid insulation is used.	-52.5
Minimum 24 Gauge Steel Versa Span³, Maximum 18 inches wide			Class 60
40	Optional-Any UL Listed rigid roofing insulation board; Any compressible blanket insulation 8 in. max thick before compression, or 6 in. max thick when located between supports ⁵	(2) Minimum No. 10-16 x 1 inch pancake head screws or No. 14-13 DPI carbon, pancake head screw when rigid insulation is used.	-30
Minimum 24 Gauge Steel Versa Span³, Maximum 18 inches wide			Class 90
41	Optional-Any compressible blanket insulation 8 in. max thick before compression, or 6 in. max thick when located between supports ⁴	(2) Minimum No. 10-16 x 1 inch pancake head or ¼-14 x 1 inch truss head screws.	-52.5

¹Unlimited Slope

²Non-decked, open framing construction

³Meets Class 4 Impact Rating

⁴Structural supports spaced maximum 48 inches oc

⁵Structural supports spaced maximum 60 inches oc

TABLE 3: UL 790 CLASS A¹ FIRE RATED WIND UPLIFT ASSEMBLIES² (continued)

System Number	Insulation	Metal Panel Attachment	Allowable Uplift Pressure ANSI/UL 580
Minimum 24 Gauge Steel Versa Span³, Maximum 10-½ inches wide			Class 90
42	Optional- Any UL Listed rigid roofing insulation board; Any compressible blanket insulation 8 in. max thick before compression, or 6 in. max thick when located between supports ⁴	(2) Minimum No. 10-16 x 1 inch pancake head screws or No. 14-13 DPI carbon, pancake head screw when rigid insulation is used.	-52.5
43	Optional-Any compressible blanket insulation 8 in. max thick before compression, or 6 in. max thick when located between supports ⁵	¼-14 x 1-¼ inch hex head screws.	-52.5
Minimum 22 Gauge Steel Versa Span³, Maximum 10-½ inches wide			Class 90
44	Optional-Any UL Listed rigid roofing insulation board; Any compressible blanket insulation 8 in. max thick before compression, or 6 in. max thick when located between supports ⁵	(2) Minimum No. 10-16 x 1 inch pancake head screws or No. 14-13 DPI carbon, pancake head screw when rigid insulation is used.	-52.5
Minimum 22 Gauge Steel Versa Span³, Maximum 12 inches wide			Class 90
45	Any compressible blanket insulation 8 in. max thick before compression, or 6 in. max thick when located between supports ⁵	(2) Minimum No. 10-16 x 1 inch pancake head or ¼-14 x 1 inch truss head screws.	-52.5
Minimum .032 Aluminum Versa Span³, Maximum 10-½ inches wide			Class 60
46	Optional- Any UL Listed rigid roofing insulation board; Any compressible blanket insulation 8 in. max thick before compression, or 6 in. max thick when located between supports ⁴	(2) Minimum No. 10-16 x 1 inch pancake head screws or No. 14-13 DPI carbon, pancake head screw when rigid insulation is used.	-30

¹Unlimited Slope

²Non-decked, open framing construction

³Meets Class 4 Impact Rating

⁴Structural supports spaced maximum 48 inches oc

⁵Structural supports spaced maximum 60 inches oc

TABLE 3: UL 790 CLASS A¹ FIRE RATED WIND UPLIFT ASSEMBLIES² (continued)

System Number	Insulation	Metal Panel Attachment	Allowable Uplift Pressure ANSI/UL 580
Minimum .032 Aluminum Versa Span³, Maximum 10-½ inches wide			Class 90
47	Optional- Any UL Listed rigid roofing insulation board; Any compressible blanket insulation 8 in. max thick before compression, or 6 in. max thick when located between supports ⁵	(2) Minimum No. 10-16 x 1 inch pancake head screws or No. 14-13 DPI carbon, pancake head screw when rigid insulation is used.	-52.5
Minimum 24 Gauge Steel Versa Span³, Maximum 10 inches wide			Class 90
48	Optional-Any compressible blanket insulation 8 in. max thick before compression, or 6 in. max thick when located between supports ⁴	(2) Minimum No. 10-16 x 1 inch pancake head screws.	-52.5
Minimum 22 Gauge Steel Versa Span³, Maximum 10 inches wide			Class 90
49	Optional-Any compressible blanket insulation 8 in. max thick before compression, or 6 in. max thick when located between supports ⁶	(2) Minimum No. 10-16 x 1 inch pancake head screws.	-52.5
Minimum 22 Gauge Steel Versa Span³, Maximum 21-¼ inches wide			Class 60
50	Optional-Any compressible blanket insulation 8 in. max thick before compression, or 6 in. max thick when located between supports ⁶	(2) Minimum No. 10-16 x 1 inch pancake head or ¼-14 x 1 inch truss head screws.	-30
Minimum .032 Aluminum Versa Span³, Maximum 10 inches wide			Class 90
51	Optional-Any compressible blanket insulation 8 in. max thick before compression, or 6 in. max thick when located between supports ⁵	(2) Minimum No. 10-16 x 1 inch pancake head screws.	-52.5

¹Unlimited Slope

²Non-decked, open framing construction

³Meets Class 4 Impact Rating

⁴Structural supports spaced maximum 48 inches oc

⁵Structural supports spaced maximum 36 inches oc

⁶Structural supports spaced maximum 60 inches oc

TABLE 4: UL 790 CLASS A¹ FIRE RATED WIND UPLIFT ASSEMBLIES

System Number	Insulation	Metal Panel Attachment	Allowable Uplift Pressure ANSI/UL 580
Minimum 24 Gauge Steel MS 200³, Maximum 18 inches wide			Class 90
52	Minimum 5 inch thick structural cement fiber unit consisting of minimum 0.95 pcf expanded polystyrene foamed plastic core laminated to 7/16 inch thick OSB structural panels between supports ³	(2) Minimum ¼-14 x 1 hex washer head screws spaced 24 inches oc	-52.5
53	Minimum 5 inch thick structural cement fiber unit consisting of minimum 0.95 pcf expanded polystyrene foamed plastic core laminated to 7/16 inch thick OSB structural panels between supports ³	(2) Minimum No. 10-12 x 1 inch pancake head screws spaced 36 inches oc	-52.5
Minimum .032 Aluminum Versa Span³, Maximum 16 inches wide			Class 90
54	Minimum 5 inch thick structural cement fiber unit consisting of minimum 0.95 pcf expanded polystyrene foamed plastic core laminated to 7/16 inch thick OSB structural panels between supports ³	(2) Minimum No. 10-12 x 1 inch pancake head screws spaced 18 inches oc	-52.5

¹Unlimited Slope

²Meets Class 4 Impact Rating

³Rabbeted into truss tees spaced maximum 48 inches oc or over structural supports spaced according to design specifications

Easy-Lock Detail

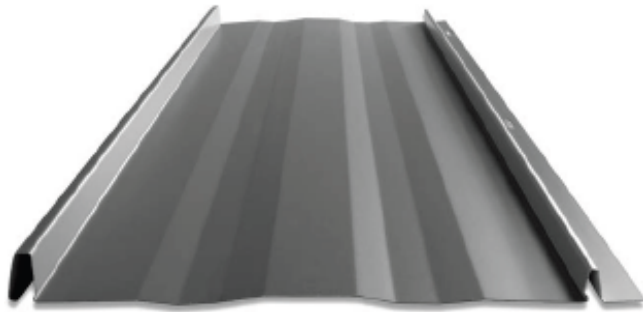

STRIATED



ACCENT RIBS
3 Accent ribs for 12" panel
4 Accent ribs for 16" & 18" panel



FLAT PAN

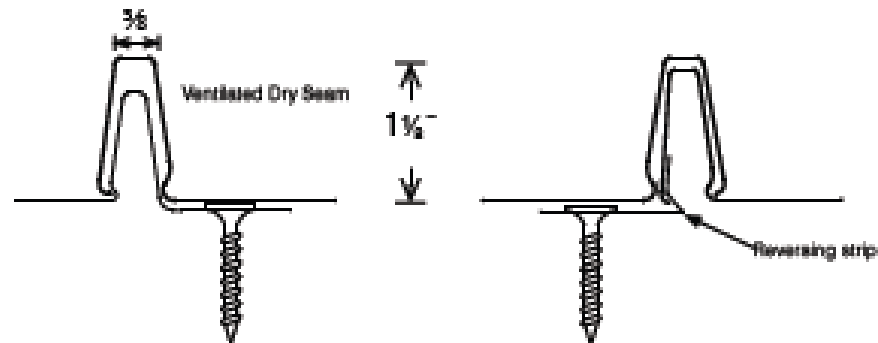

Versa-Span Detail

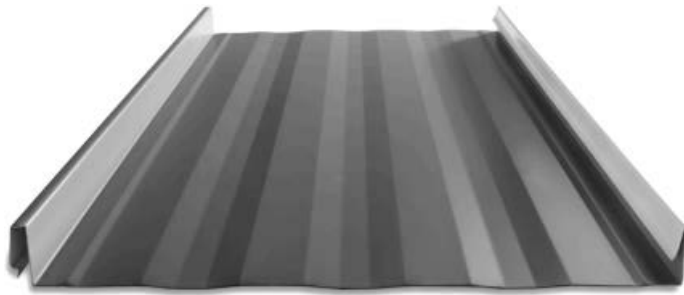

STRIATED

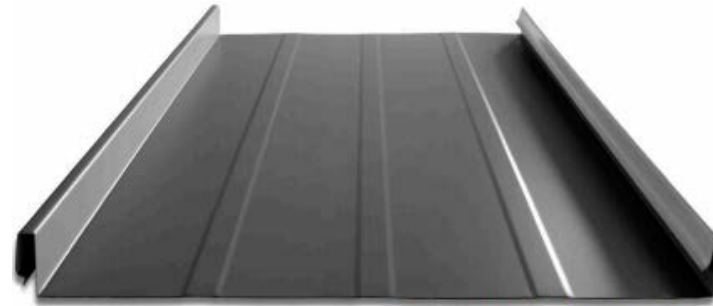

ACCENT RIBS
2 Accent ribs for 12" to 14 1/4" panel
3 Accent ribs for 16" to 18" panel

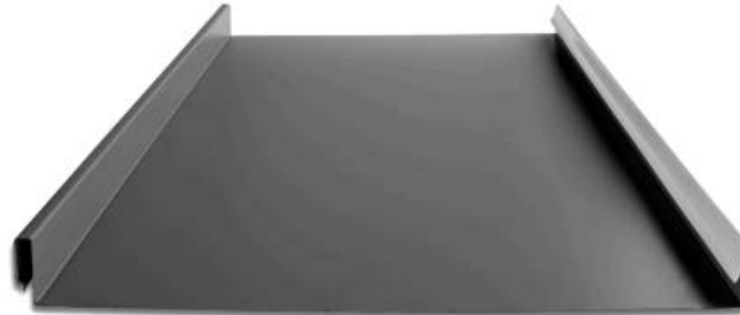

FLAT PAN

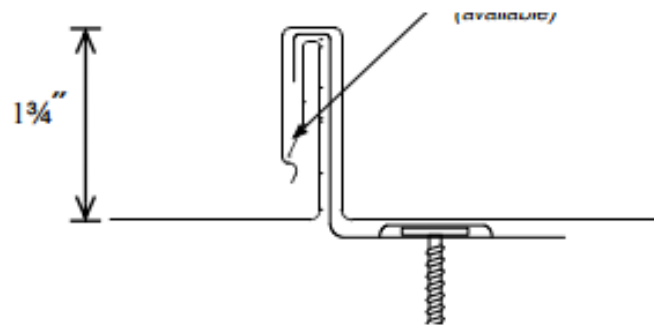

18 gauge Galv.

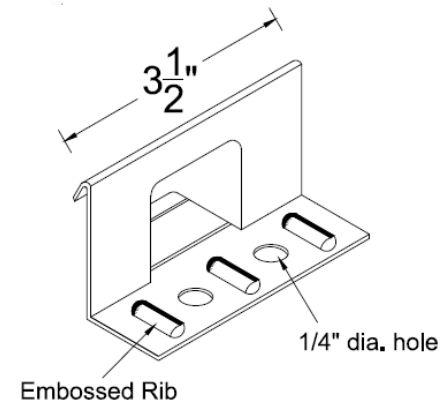
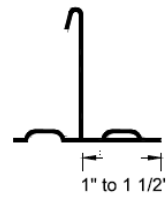

MS-100, MS-150 Detail



STRIATED

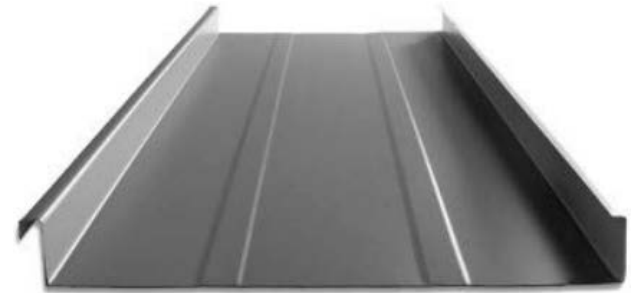

ACCENT RIBS



FLAT PAN

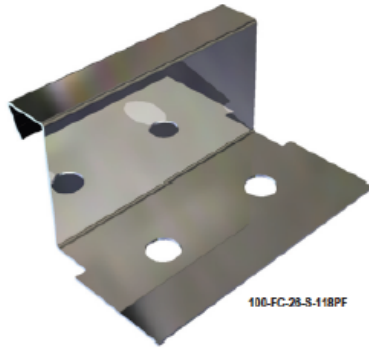

100-FC-25-S-118PF

1" MS100
1½" MS150

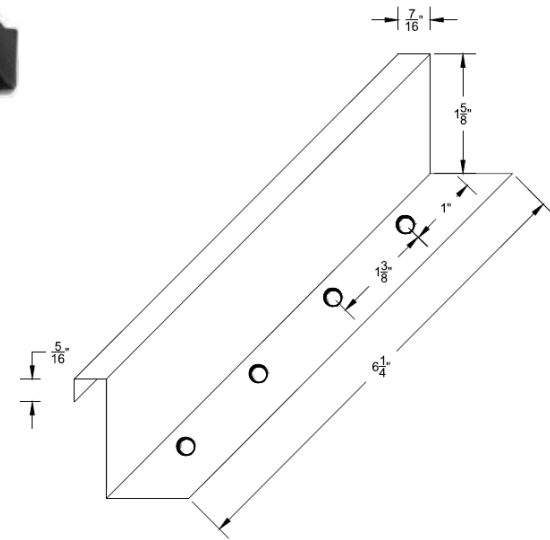
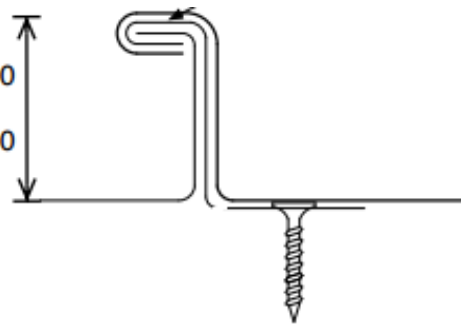

Premier-Lock Detail

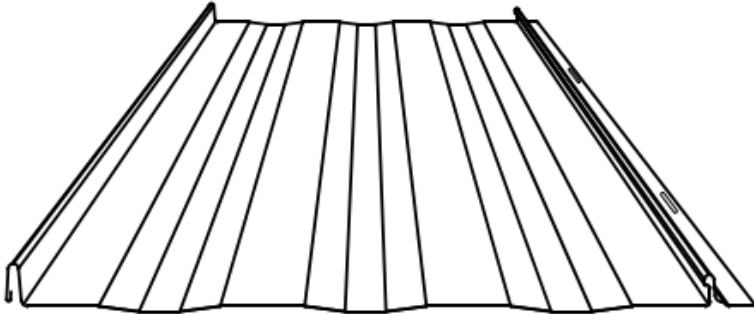

STRIATED

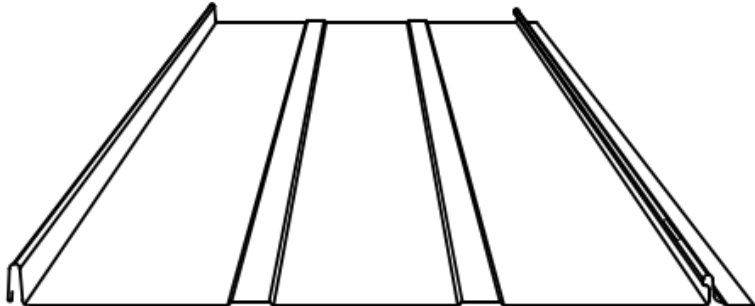

ACCENT RIBS

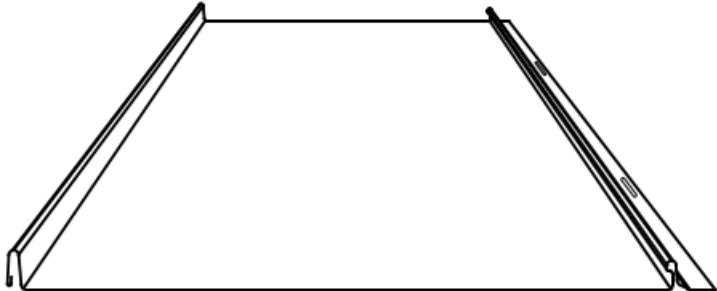

FLAT PAN

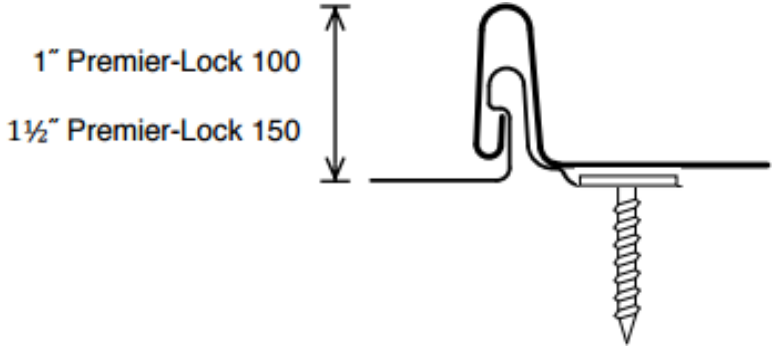

Clip-Lock Detail

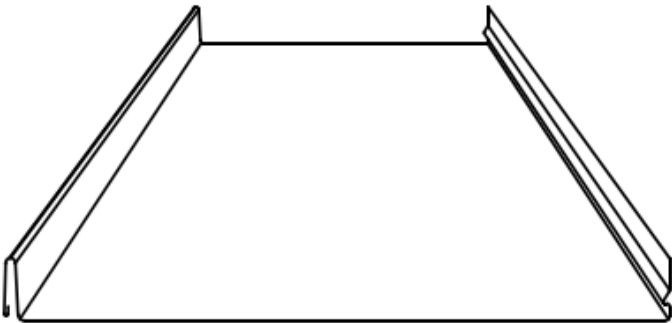
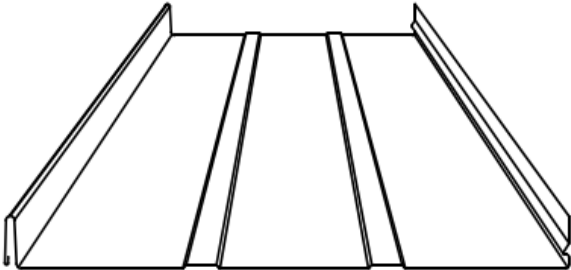
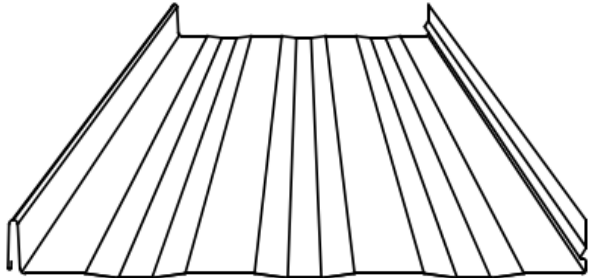

FLAT PAN

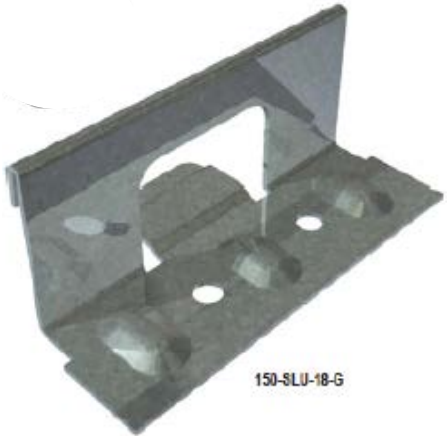

150-SLU-18-G

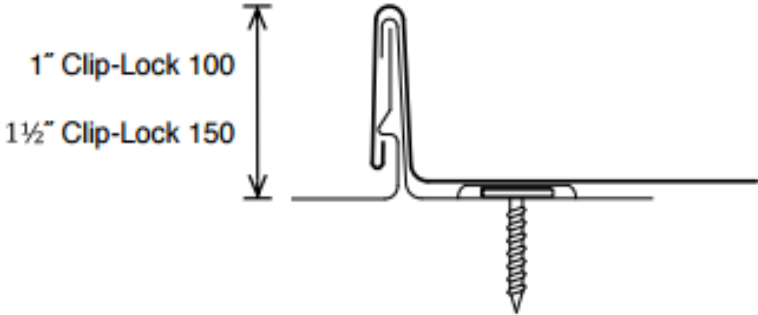

MS-200 Detail

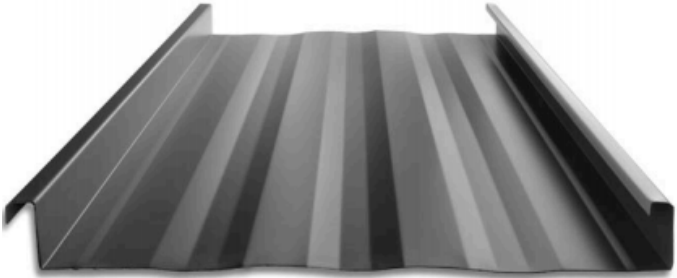

STRIATED

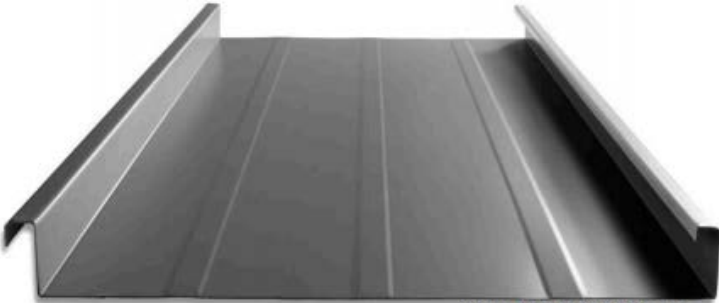

ACCENT RIBS
 2 Accent ribs for 12" to 14 1/4" panel
 3 Accent ribs for 16" to 18" panel

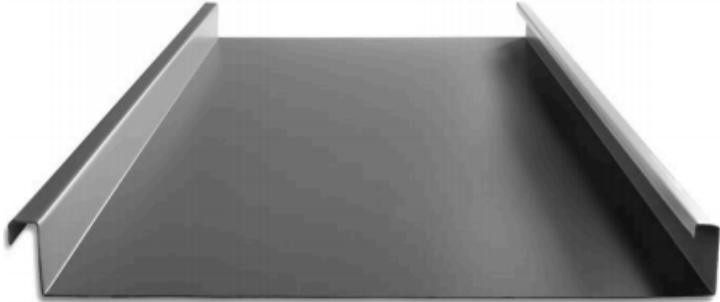

FLAT PAN

90° SEAM DETAIL

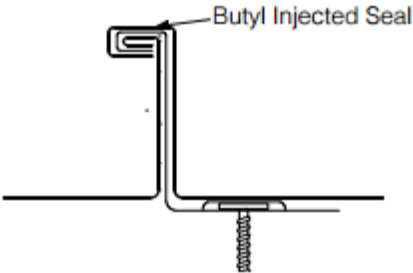

180° SEAM DETAIL

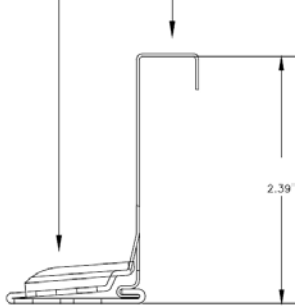
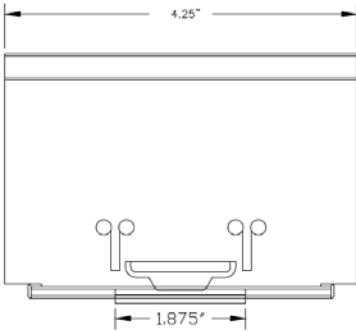
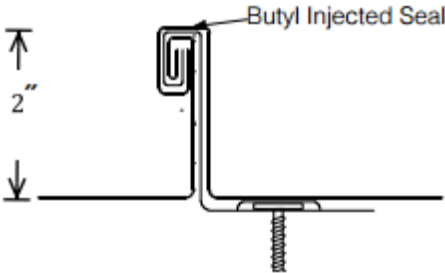

T Panel Narrow Batten Detail

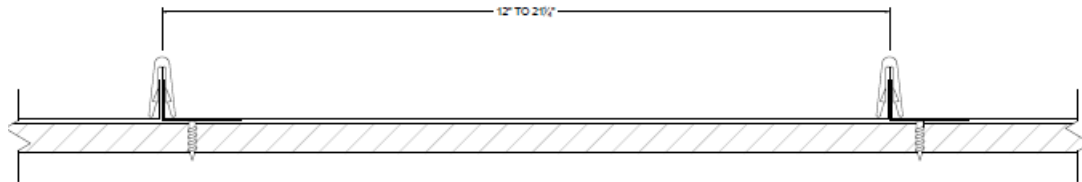
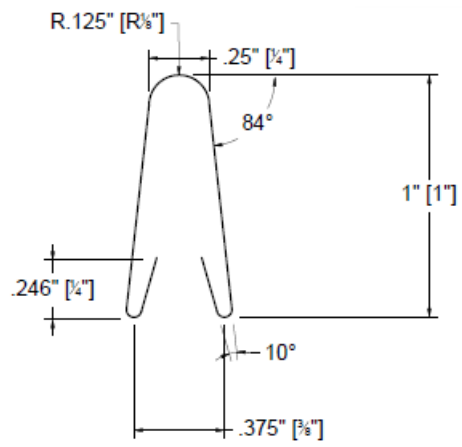
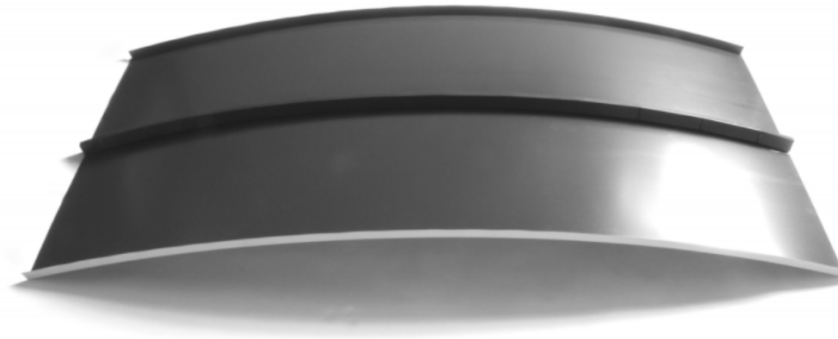

© 2019 UL LLC

This UL Evaluation Report is not an endorsement or recommendation for use of the subject and/or product described herein. This report is not the UL Listing or UL Certification Report that covers the subject product. The subject product's UL Listing or UL Certification is covered under a separate UL Report. UL disclaims all representations and warranties whether express or implied, with respect to this report and the subject or product described herein. Contents of this report may be based on data that has been generated by laboratories other than UL that are accredited as complying with ISO/IEC Standard 17025 by the International Accreditation Service (IAS) or by any other accreditation body that is a signatory to the International Laboratory Accreditation Cooperation (ILAC) Mutual Recognition Arrangement (MRA). The scope of the laboratory's accreditation shall include the specific type of testing covered in the test report. As the accuracy of any non-UL data is the responsibility of the accredited laboratory, UL does not accept responsibility for the accuracy of this data.

