

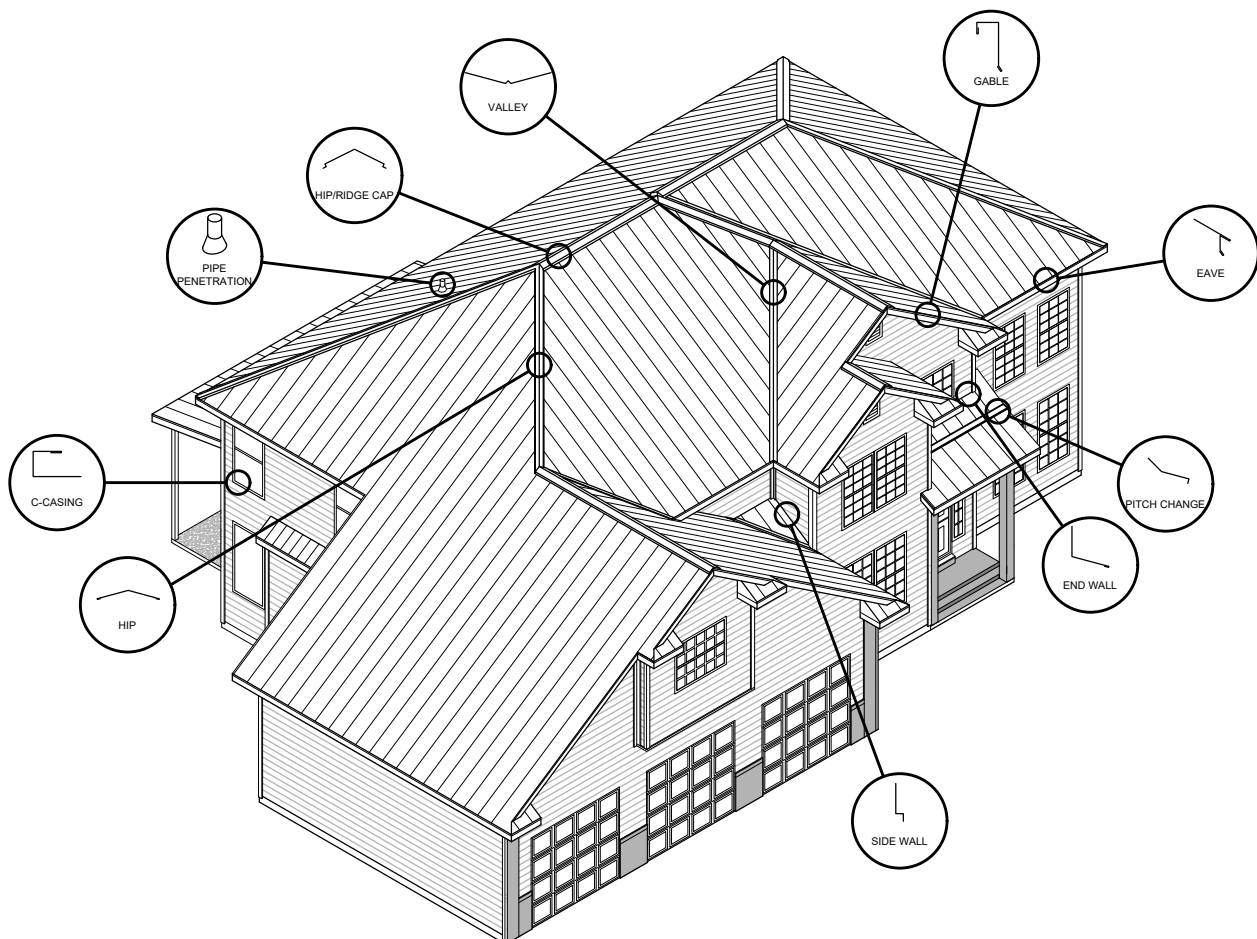

SmoothWall™, ShadowLine™ & Lifetime Soffit™ Installation Guide



Panel Specifications	1-6	FLASHINGS	
Introduction	7	Wall C-Flashing	15
Handling and Storage	8	Base Flashing	16
Taylor Delivery Fleet	9	Outside Corner	17
Delivery & Will Call/Loading	10	Inside Corner	18
Tools	11	Z-Flashing	19
Fasteners	12	Z-Backer	20
SmoothWall™ and ShadowLine™		Soffit Panel Installation	21
Oil Canning	13	Soffit C & Angle Flashings	22
Panel Installation	14	Fascia Board & H-Flashings	23
Lifetime Soffit™ Panel Installation	21	Drip Flashing	24
		Standard Flashing Selections	25-32





SmoothWall™ will give your commercial or residential projects a clean monolithic appearance. These panels are a perfect fit to be used on walls, soffits and fascia. With the different panel styles available, your designs will come alive.

KEY FEATURES

- 12" and 12-5/8" coverage options
- 24 & 22 gauge Tru-gauge™
- Custom Lengths 3' to 35'
(Inquire for longer or shorter lengths)
- 2' Shortcut capability *(Fee applicable)*
- Concealed Fasteners: fasteners cannot leak
- ASTM E1592 - Structural uniform static air pressure
- ASTM E283, ASTM E330, ASTM E331
- Versatile in wall and soffit applications
- Panel options: Vented, Striations, Single V-Groove, Double V-Groove, and Flat Pan
- "Oil canning" is an inherent characteristic of roof and wall products, and not a defect, which is not a cause for panel rejection

PANEL PROFILES

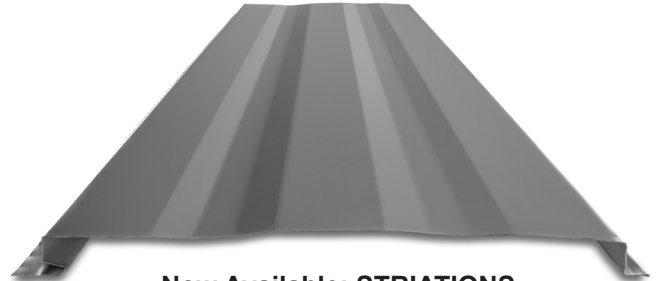
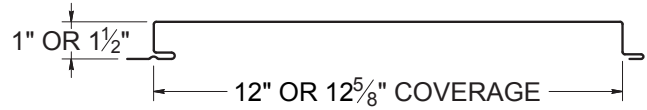

Now Available: STRIATIONS



DOUBLE V-GROOVE
or Single V-Groove available



FLAT PAN



2 FLAT PAN PANELS

MATERIAL SPECIFICATIONS

- 24 & 22 gauge Kynar 500® Painted Steel
.0236" (Thickness prior to painting)
G-90 Galvanized or AZ-50
- 24 & 22 gauge bare Zinalume® Plus AZ-55
(No finish warranty – 25 yr. perforation warranty)
- ▲ 22 gauge Kynar 500® Painted Steel
.029" (Thickness prior to painting)
G-90 Galvanized or AZ-50
- 22 gauge Rusteel Plus™ (A606)
- Kynar 500® and substrate testing data available
(See website)

KEY FEATURES

- 21 Standard Colors, 5 Metallic Colors and 4 Specialized Materials
- Kynar 500® Paint System - the ultimate in exterior durability and color retention
- "Cool" color pigments are specially designed to reflect infrared light, reducing heat gain to dwelling, and conform with ENERGY STAR® criteria
- Superior quality, two coat, 70% resin finish, applied at a 1 mil. thickness
- 40 year residential paint warranty
- 20 and 30 year commercial paint warranty: Contact TMP for warranty specifications

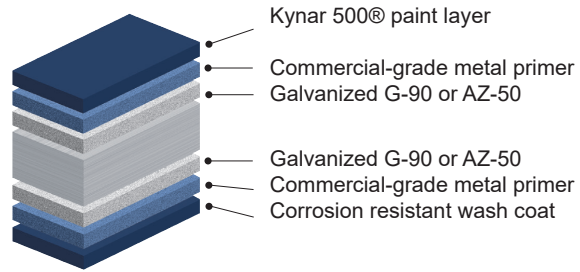

40-Year Residential / 20 and 30 Year Commercial Manufacturer's Limited Warranty

STANDARD COOL KYNAR 500® COLORS

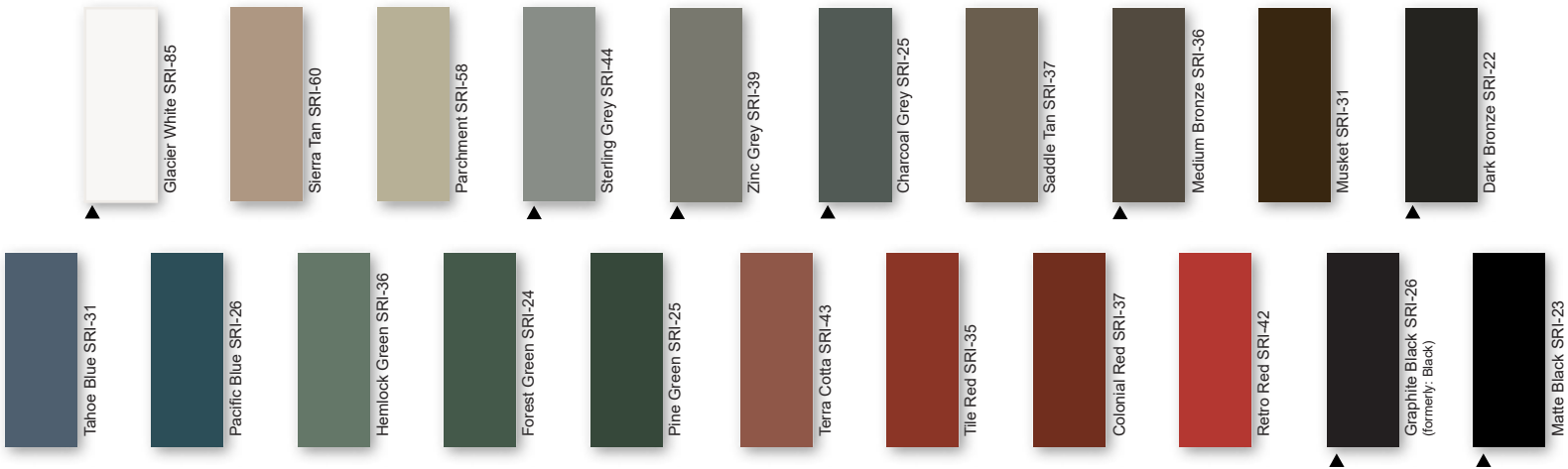

PREMIUM METALLIC COOL KYNAR 500® COLORS

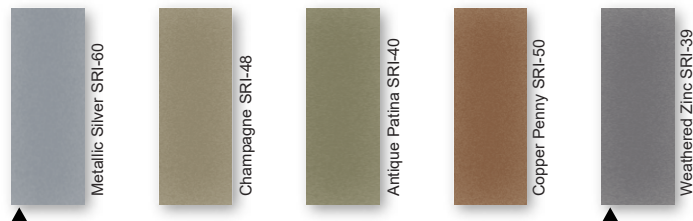

SPECIALIZED MATERIAL

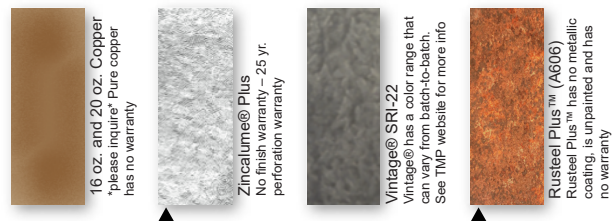

These printed chips provide a close representation of the colors.

Metal samples are available upon request. Coatings are low gloss 10-15% sheen.

SRI = Solar Reflective Index. SRI values listed above are in accordance with ASTM E 1980 and are based on actual testing. ***Oil canning is not a cause for material rejection***

Gauge	SmoothWall	
	1" x 12"	1.5" x 12"
24	Pounds per LF & SQFT: 1.28	Pounds per LF & SQFT: 1.36
22	Pounds per LF & SQFT: 1.61	Pounds per LF & SQFT: 1.71



ShadowLine™ will give your commercial or residential project a unique appearance. The panel reveal displays a shadowing effect that changes throughout the day, giving depth to your building. These panels are a perfect fit to be used on walls, soffits and fascia. With the 4 different panel styles available, your designs will come alive.

KEY FEATURES

- 11-1/2" to 15" coverage
- 24 & 22 gauge Tru-Gauge™
- Custom Lengths 3' to 35'
(Inquire on longer or shorter lengths)
- 2' Shortcut capability *(Fee applicable)*
- Concealed Fasteners: fasteners cannot leak
- ASTM E283, ASTM E330, ASTM E331
- Versatile in wall and soffit appearance
- Panel options: Vented, Striations, Single V-Groove, Double V-Groove, and Flat Pan
- "Oil canning" is an inherent characteristic of roof and wall products, and not a defect, which is not a cause for panel rejection

PANEL PROFILES

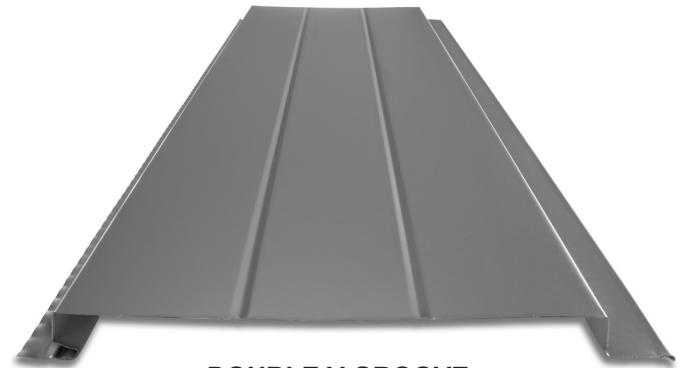
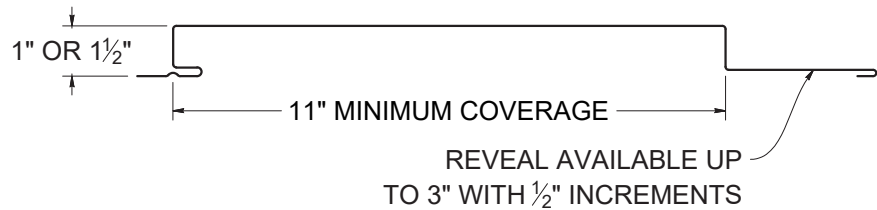

DOUBLE V-GROOVE
or Single V-Groove available

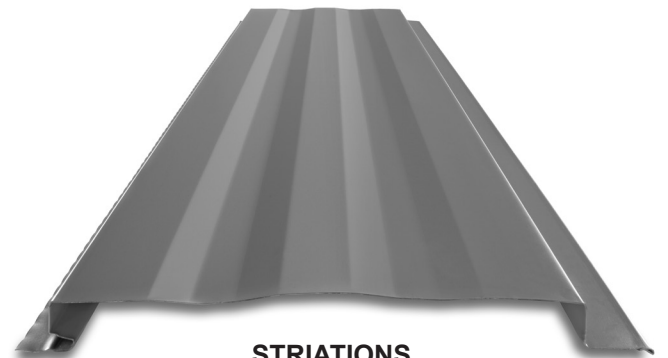

STRIATIONS



2 FLAT PAN PANELS

(2" REVEAL SHOWN)

REVEAL AVAILABLE: 1/2" to 3" in 1/2" INCREMENTS

MATERIAL SPECIFICATIONS

- 24 & 22 gauge Kynar 500® Painted Steel
.0236" (Thickness prior to painting)
G-90 Galvanized or AZ-50
- 24 & 22 gauge bare Zincolume® Plus AZ-55
(No finish warranty – 25 yr. perforation warranty)
- ▲ 22 gauge Kynar 500® Painted Steel
.029" (Thickness prior to painting)
G-90 Galvanized or AZ-50
- 22 gauge Rusteel Plus™ (A606)
- Kynar 500® and substrate testing data available
(See website)

KEY FEATURES

- 21 Standard Colors, 5 Metallic Colors and 4 Specialized Materials
- Kynar 500® Paint System - the ultimate in exterior durability and color retention
- “Cool” color pigments are specially designed to reflect infrared light, reducing heat gain to dwelling, and conform with ENERGY STAR® criteria
- Superior quality, two coat, 70% resin finish, applied at 1 mil. thickness
- 40 year residential paint warranty
- 20 and 30 year commercial paint warranty: Contact TMP for warranty specifications

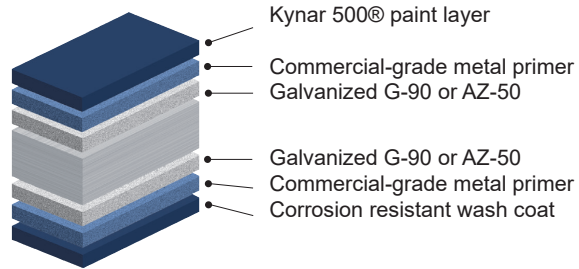

40-Year Residential / 20 and 30 Year Commercial Manufacturer's Limited Warranty

STANDARD COOL KYNAR 500® COLORS

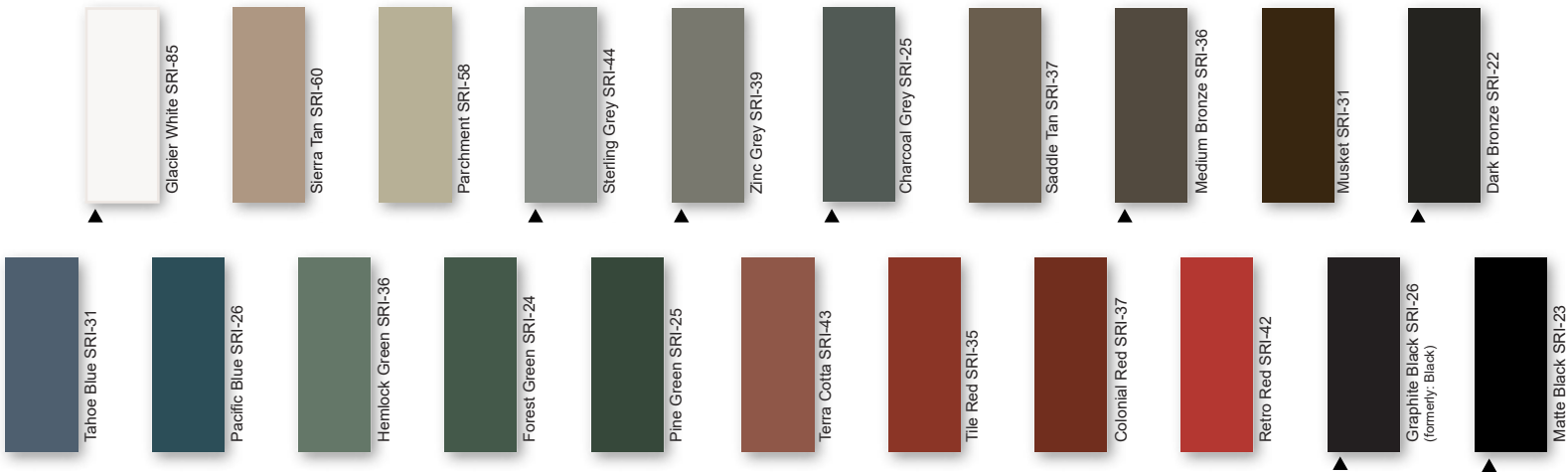

PREMIUM METALLIC COOL KYNAR® COLORS

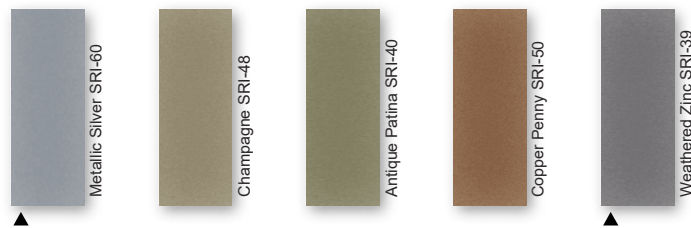

SPECIALIZED MATERIAL

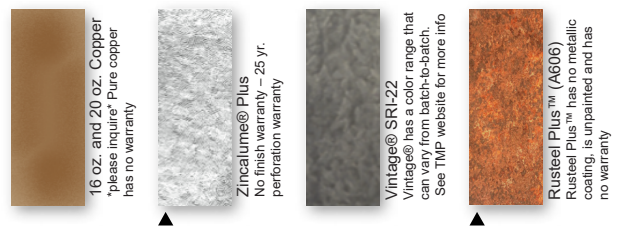

These printed chips provide a close representation of the colors.

Metal samples are available upon request. Coatings are low gloss 10-15% sheen.

SRI = Solar Reflective Index. SRI values listed above are in accordance with ASTM E 1980 and are based on actual testing.***Oil canning is not a cause for material rejection***

Standard Weight			
Gauge	Color	LBS SQFT	LBS LF
24	Kynar	1.28	1.28
22	▲	1.61	1.61





Lifetime Soffit™ will give your commercial or residential projects a clean monolithic appearance. These panels are a perfect fit to be used on walls, soffits and fascia. With the different panel styles available, your designs will come alive.

KEY FEATURES

- 12" and 12-5/8" coverage options
- 24 & 22 gauge Tru-gauge™
- Custom Lengths 3' to 35'
(Inquire for longer or shorter lengths)
- 2' Shortcut capability (Fee applicable)
- Concealed Fasteners: fasteners cannot leak
- 6.16 sq. inch free air flow per lineal foot of perforated panel
- ASTM E1592 - Structural uniform static air pressure
- ASTM E283, ASTM E330, ASTM E331
- Versatile in wall and soffit applications
- Panel options: Vented, Striations, Single V-Groove, Double V-Groove, and Flat Pan
- "Oil canning" is an inherent characteristic of roof and wall products, and not a defect, which is not a cause for panel rejection

PANEL PROFILES

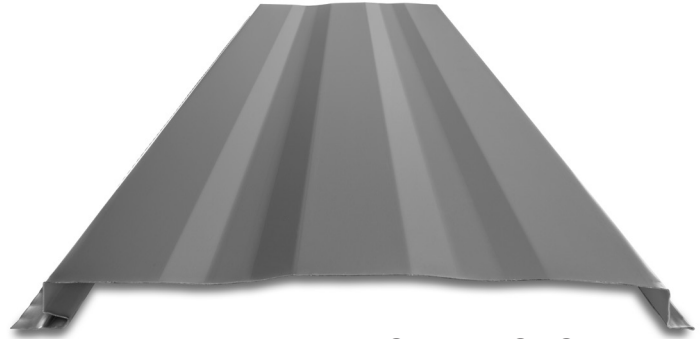
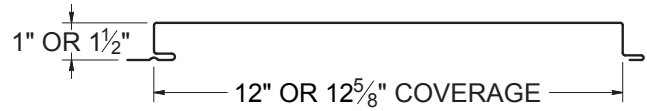

Now Available: STRIATIONS

Striations offer the best solution to help minimize oil canning

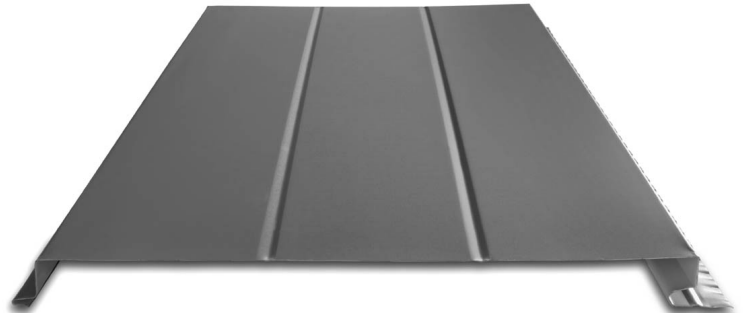

DOUBLE V-GROOVE (shown)

or Single V-Groove available



FLAT PAN



2 VENTED PANELS

MATERIAL SPECIFICATIONS

- 24 & 22 gauge Kynar 500® Painted Steel .0236" (Thickness prior to painting) G-90 Galvanized or AZ-50
- ▲ 22 gauge Kynar 500® Painted Steel .029" (Thickness prior to painting) G-90 Galvanized or AZ-50
- 24 & 22 gauge bare Zinalume® Plus, AZ-55 (No finish warranty – 25 yr. perforation warranty)
- 22 gauge Rusteel Plus™ (A606)
- Kynar 500® and substrate testing data available (See website)

KEY FEATURES

- 21 Standard Colors, 5 Metallic Colors and 4 Specialized Materials
- Kynar 500® Paint System - the ultimate in exterior durability and color retention
- "Cool" color pigments are specially designed to reflect infrared light, reducing heat gain to dwelling, and conform with ENERGY STAR® criteria
- Superior quality, two coat, 70% resin finish, applied at a 1 mil. thickness
- 40 year residential paint warranty
- 20 and 30 year commercial paint warranty: Contact your sales rep. for warranty specifications

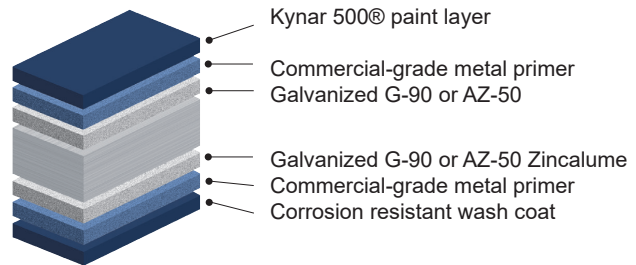

40-Year Residential / 20 and 30 Year Commercial Manufacturer's Limited Warranty

STANDARD COOL KYNAR 500® COLORS



PREMIUM METALLIC COOL KYNAR® COLORS

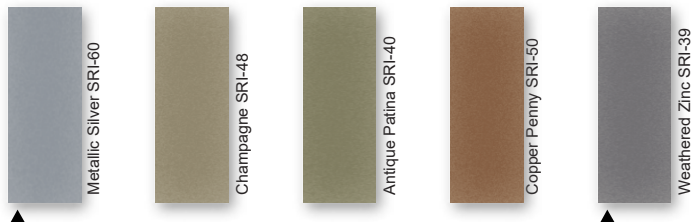

SPECIALIZED MATERIAL

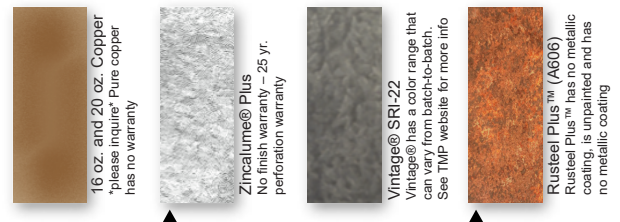

These printed chips provide a close representation of the colors.

Metal samples are available upon request. Coatings are low gloss 10-15% sheen.

SRI = Solar Reflective Index. SRI values listed above are in accordance with ASTM E 1980 and are based on actual testing. ***Oil canning is not a cause for material rejection***

Standard Weight			
Gauge	Color	LBS SQFT	LBS LF
24	Kynar	1.28	1.28
22	▲	1.61	1.61



Taylor Metal Products, **SmoothWall™**, **Lifetime Soffit™** & **ShadowLine™** panels are designed for use on residential and commercial structures.

SmoothWall™, **Lifetime Soffit™** & **ShadowLine™** panels are available in standard lengths between 4 feet and 25 feet in 1/4" increments. For best results, TMP recommends panel lengths of 12' or less. For taller wall heights, use a Z-Backer (ZB - page 19) to break up the distance into two panels. Panels shorter than 4 feet are available, however, they are subject to a per panel handling charge. Please see current price list.

The **SmoothWall™** & **ShadowLine™** panels can be used on vertical wall or mansard applications to provide an appealing, long lasting alternative to common siding products or as an accent area to add color or texture to any building. SmoothWall™ panels are smooth faced and available with striations or an optional center V-Groove (6" reveal) or two V-Grooves (4" reveal).

SmoothWall™ panels are also available with a polystyrene backer. The primary function of the backer is to provide support for the panel to minimize denting and buckling due to impact. When using the polystyrene backer it is advisable to use solid sheathing or space sheathing set 4 to 6 inches apart to gain the greatest benefit of the polystyrene. The entire panel is not filled with polystyrene, therefore it is not intended to provide insulation or be used for sound absorption, although some insulation value and sound absorption can be gained from the polystyrene.

The **Lifetime Soffit™** provides an attractive alternative to plywood or open soffits and offers ventilation when incorporating perforated soffit panels into the system. Lifetime Soffit™ panels are available in smooth (solid) or perforated, with an optional center v-groove.

Please contact Taylor Metal Products for use of custom flashing details as they pertain to specific conditions or to discuss a specific project.

Conformity to local building codes, details for specific applications, and use of safety and health procedures is the sole responsibility of the installer.

These installation instructions are intended to offer suggested application procedures for common building construction. No attempt is made to provide installation details for every application or possible use. Taylor Metal Products, assumes no liability for the improper installation of the panel nor for any personal injury or property damage that may occur with the product's use.

**Oil Canning - All light gauge metals can display waviness often referred to as "oil canning." This is caused by steel mill tolerances, substrate variation and relative reflectivity. "Oil canning" is an inherent characteristic of steel products, not a defect, and is not a cause for material rejection.*

Handling

Handle materials with care when off loading or moving materials to avoid damage to panels or flashings. Long panels may require two or more pick-up points, properly spaced to avoid damaging panels. Plan ahead. Contact Taylor Metal Products for recommendations on handling/hoisting long panels.

Wear clean cotton gloves when handling copper or unpainted Zincoalume® to avoid leaving fingerprints and smudges. While fingerprints or smudges will not harm the material, they will temporarily leave markings on the material until the material weathers.

Wear clean, soft-soled shoes when walking on roofing panels to avoid damage to the painted finish. Take care that sand, gravel, dirt etc. sticking to your shoes is not carried onto the roof, scratching or otherwise damaging the finish on the roofing material.

Walking on asphalt impregnated felt paper, especially on a hot day, can cause the asphalt to stick to your shoes and be tracked onto the roofing material. Do not walk on major ribs of panels. Do not walk on panels that have not been completely installed.

Take care when painting to avoid getting over spray on the roofing material. Remember that wind can carry paint particles some distance. Over spray can cause the finish of the roofing material to look dull and may void your warranty.

Do not allow panels to contact preservative-treated lumber. Water and ice shield material is effective in preventing a corrosive reaction between steel products and pressure-treated lumber.

Storage

Store the panels, flashings, and accessories in a dry, well ventilated area, on level ground. Slightly elevate one end of bundles to allow drainage of wet materials. Support panels with blocks throughout escalation in elevation to prevent permanent deformation. If covering, allow ventilation around the panels.

Protect panels against standing water and condensation between adjacent surfaces. If panels become wet, immediately separate sheets, wipe dry with clean cloth, and keep sheets separate for air-drying.

Painted metal roofing panels will have a clear plastic film applied to the lower rib of the panel to protect the seam during transportation and handling. Flashing and flat sheet may have a plastic film for protection. Remove this film prior to installation of the panels.

Products with film should not be stored in direct sunlight or under other UV source, and should not be left in extreme heat or cold for long periods.

Secure materials on the ground or roof to prevent winds from moving the materials, especially when leaving the site. Wind-blown materials may cause damage to the material, property or persons. Avoid installing panels in windy conditions.

Safety considerations are the responsibility of the installer and their crew. Be sure to **use common sense** and accepted industry standard safety practices when installing roofing materials. Always use proper safety equipment and attire to minimize risk of cuts or other injuries.

Delivery Fleet



Delivery Fleet

Taylor Metal Products prides itself with quick lead times delivered with our fleet of semi trucks. Our fleet of trucks are owned and operated by TMP. All of our drivers are Taylor Metal Products employees, so when your truck rolls in to deliver, you are dealing with Taylor Metal Products.

Expect consistent and exceptional service with short lead times. The inhouse fleet allows for efficient and cost-effective delivery.



Mounted on the rear of our semitrailer, the trailer-mounted "piggy-back" forklift will accompany you right to your place of use, opening up unprecedented possibilities in terms of transportation. It can travel sideways, carrying panels up to 40' long, allowing delivery in locations that would typically be considered impossible to reach.

Save time and effort while avoiding potential loading and transport issues; have experienced TMP personnel deliver and unload your order.



Delivery

We will make every attempt to deliver material to the desired location. We may be unable to gain access on tight corners or steep terrain. If the site is deemed inaccessible by our driver, the customer may choose an alternate delivery site within a reasonable proximity. If we are unable to make the alternate delivery, additional charges may be assessed.

The customer is responsible for:

- Determining adequate access for delivery ahead of time.
- Meeting the delivery at the agreed upon time.
- Providing adequate resources (1-4 people as needed) for off loading materials.
A charge of \$100 per hour may be added for deliveries that go beyond their allotted time.
- Checking the shipment at the time of delivery.
- Verifying material quantities against the shipping/packing list.
- Noting any damage or discrepancies upon the paper work at the time of delivery and notifying Taylor Metal Products within 48 hours of delivery.

Delivery times are usually scheduled one day in advance. Taylor Metal Products will make every effort to make the delivery at the scheduled time. Please be aware that there may be conditions beyond our control such as traffic, mechanical failures, road closures, etc. which may affect our schedule. If a delay is expected, you will be notified in advance of delivery.

Will Call & Loading

Flatbed trailers and trucks are best suited to transport metal roofing materials. These can be loaded from the side with a forklift and tied down in a safe and secure manner.

We are not able to load materials onto vehicles and/or trailers which are not suitable or may be hazardous to load. Please be aware that if we find a vehicle to be inappropriate, we reserve the right to refuse to load your order.

Unacceptable examples include: boat trailers, vans, buses, motor homes, campers and box trailers. Pickup racks which do not have sufficient supports for the weight or are not long enough to support bundles are also unacceptable.

Taylor Metal Products is not responsible to tie down loads nor do we provide any tie down materials. Please bring tie downs to secure your load (string or twine are **not** acceptable for this purpose).

Consider having your order delivered on one of our trucks with a piggy back forklift.



The following tools/safety equipment may be used for proper installation:

- Screw Gun: Clutch type, variable torque, cordless screw guns will give the best results.
 - Extra batteries
 - Bit holder - magnetic
 - #2 square drive bits or philips drive bits (for panel screws)
 - 1/4" Hex head - magnetic - bit driver (for woodfast flashing screws)
 - 1/8" drill bit (for rivets & pre-drilling fastener holes)
 - Belt & holster (keeps all the above tools safely on your hip)

Cutting Tools:

- Cutters/Offset (curved jaw) left & right (for precision cutting, long cuts)
- Snips (straight jaw) left & right (for short cuts & circular cuts)
- Electric Shears (aids in long panel rips)

CAUTION: POWER SAWS MAY CAUSE PANEL DAMAGE!





TMP recommends cutting panels and flashings with tin snips or shears.

We do NOT recommend the use of saw blades or abrasive wheels - use may void warranties and reduce longevity, especially in marine environments.

WARNING : Filings, debris and metal chips must be wiped off panels each day to avoid corroding the panels and causing rust specks or stains. Water can cause non-finished metal shaving to bind to panels after rust develops damaging panels. Failure to properly install panels and remove debris may void warranties.

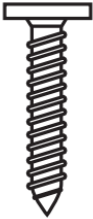
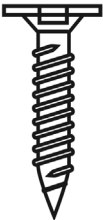
Other Tools:

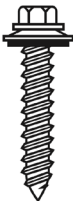
- DeBurring Tool
- Hole Punch (for pre-punching holes in metal)
- Rubber Mallet - SoftType (for adjusting panels & flashings)
- Quick Square, Framing Square & Bevel Square (aids in squaring flashings & panels)
- Duck Bill Vise Grips/Pliers (for various bending)
- Upender Tools (used for panel-prep, available at TMP)
- Tape Measure
- Rivet Tool (for riveting flashings)
- Marking pen or grease pencil
- Chalk Line (for marking long panel rips and to align panels)
- Protective gloves to protect hands
- Cotton gloves for working with copper (to protect against fingerprints on finish)
- Ear plugs
- Safety harness kit

FASTENER	DESCRIPTION	USE
	<p>Pancake Head, Sharp point #10 x 1" #2 Phillips Head</p>	<p>The pancake head screw is recommended for panel attachment and is a concealed fastener.</p>
	<p>Waferhead Srew, Sharp point #9-16 x 1" #2 Phillips/Square Drive #9-16 x 1-1/2" #2 Square Drive</p>	<p>Waferhead screws are used for attaching the panels to a wood deck or substrate. They are concealed fasteners and made of carbon steel coated with Zinc and an Oxyseal/Xylon Coating for long life.</p>
	<p>Lath Head Screw, Sharp Point #8 x 9/16"</p>	<p>While generally not recommended for most applications, this concealed fastener is useful for areas where a longer fastener will penetrate the substrate and exhibit an objectionable appearance, such as exposed overhangs. The pull out rating for this fastener is less than the waferhead, so these fasteners need to be placed more often.</p>
	<p>Woodfast Screw, Sharp Point #9-16 x 1" 1/4" Hex Drive- Color Match #9-16 x 1/2" 1/4"</p>	<p>Woodfast screws are recommended for attaching metal to wood in some cases metal to metal. They are exposed fasteners.</p>
	<p>Stitch Screw, Sharp Point #12 x 3/4" 1/4" Hex Drive-Color Match</p>	<p>Stitch Screws are used to attach metal to metal such as lap joints in flashing. They can be used interchangeably with rivets.</p>
	<p>Rivets #43 (1/8" x 1/8") Stainless Steel rivet Color Matched or non-painted.</p>	<p>Rivets are used to attach metal to metal such as lap joints in flashing.</p>

When installing SmoothWall panels, it is crucial to take certain precautions to minimize the occurrence of oil canning. It is important to note that oil canning is a natural characteristic of metal panels and should not be considered a reason for rejection. One tried and true way to limit oil canning with SmoothWall panel is adding a metal Z (or backer rod) behind that panel that is fabricated slightly larger than the panel depth. When the Z is placed in the middle of the panel it creates a consistent convex bow to the panel that help relieve stress on the panel and limits oil canning.

Substrate must be true and plumb.

Whether the panels are being installed on a plywood substrate or metal framing (Zee and Hat), it is essential to ensure that they are placed on a flat and plumb surface. An effective way to achieve this is by utilizing lasers and string lines in conjunction, which will reveal any substrate variations. As needed, shims can then be added to maintain the panels flatness.

Fastening

When it comes to fastening, it is essential to avoid overtightening. Excessive tightening can worsen oil canning and result in panel bulging. To address this, it is crucial to select the appropriate fastener type. For SmoothWall panels, pancake head screws should be used, as opposed to bugle head screws. Bugle head screws can cause dimpling at the screw flange, which will then telegraph across the entire panel, exacerbating oil canning issues. Pancake head screws, on the other hand, sit flat against the metal flange, providing a more even distribution of pressure. However, even with pancake head screws, it is important not to over-tighten them.

If extreme expansion and contraction is an issue, the installer may need to compensate for this by drilling pilot holes at each fastener location. Pilot holes should be twice the size of the fastener being used.

Additionally, fasteners must be installed straight, as angled installation can create unnecessary pressure on the panels and lead to oil canning and bulging.

Installation Direction.

In terms of installation direction, TMP recommends installing SmoothWall panels from top to bottom. Installing from the bottom up can result in the female leg of the seam holding water, which can lead to premature failure. By installing from top to bottom, the panels can rest on the fastener below, reducing the likely hood of oil canning.

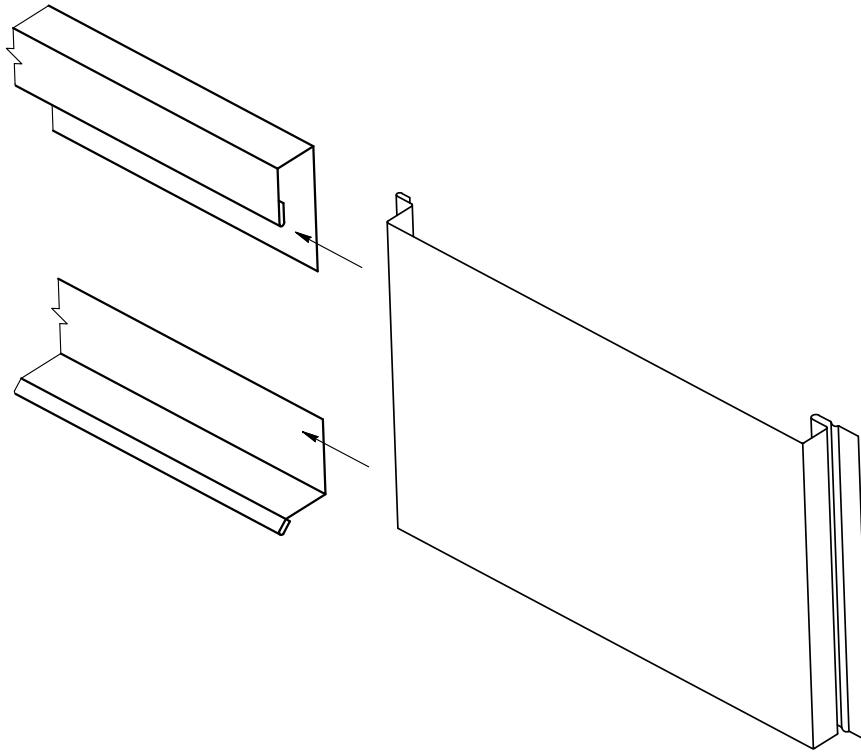

SmoothWall™/ ShadowLine™ Panel Installation

SmoothWall™/ ShadowLine™ panels are attached to the wall by fastening the wide flange of the panel to the substructure and can be attached to solid or space sheathing, with the space sheathing at no greater than 2' on center. A vapor barrier, such as 30lb felt paper, should be used over the sheathing. Fasten the panels to the sheathing through the wide flange every two feet (maximum).

Flashing details may vary with the application. It is most common to use a C-flashing at the top of the panel and a drip or sill type flashing at the bottom of the panel. C-flashing is typically used around the sides and bottom of window and door penetrations. Sill flashing is used at the top of windows and doors. Outside and inside corner flashings are also common.

Typical installation sequence: Fasten C-flashing at the top of the wall and the drip flashing at the bottom of the wall. Slide the panel into the C-flashing until it clears the drip flashing and push the panel against the wall until flat, making sure the panel is straight and vertical, pull the panel down until it meets with the drip flashing, leaving 1/16" to 1/8" gap between panel and drip flashing. Fasten the panel through the wide flange and into the sheathing.

The next panel is installed by placing the top of the panel into the C-flashing and sliding the short leg of the panel into the groove on the previous panel and pushing the panel against the last panel installed until there is little or no gap. Adjust the panel up or down to align with previous panel and fasten the panel into place. Repeat the process on subsequent panels. Check for plumbness every few panels to keep straight.

SmoothWall™/ ShadowLine™ C-Flashing Application

- The C-flashings are applied to the wall, attached every 24" to 48" with a waferhead screw. Apply C-flashing at the top of the wall or when starting and finishing panel runs if no corners are used. For longer runs, it is usually better to apply 10' of flashing on each end at a time, that way you don't have to slide panels a great distance.
- Slide the wall panels into the channel created by the C-flashing. The short leg of the panel should be pointed into the C-flashing at the start of the run. Be sure to fasten the panel to the structure at least every 24" through the wide flange of the panel.
- Successive panels are installed the same way, but are installed so they attach to the previous panel. Push the panels together so there is little or no gab between them.

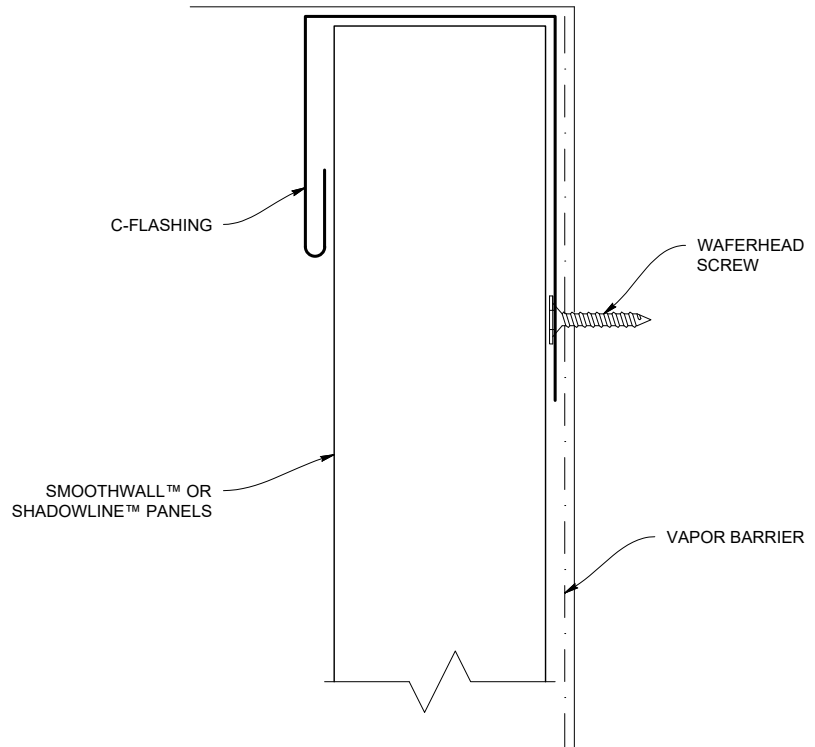

PART SHOWN: C-FLASHING
(SW100CF / SH100CF)

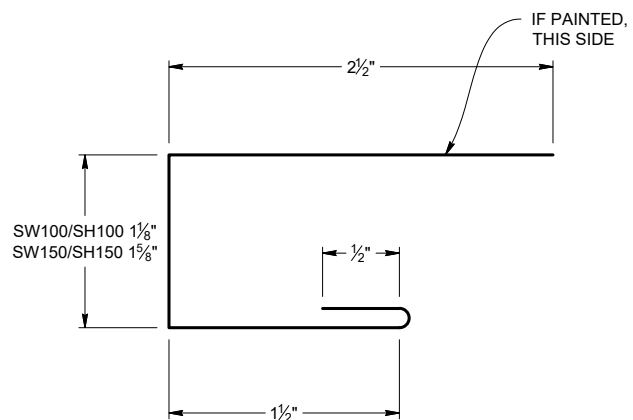

SmoothWall™/ ShadowLine™ Base Flashing Application

- Place the base flashing over the ledge/sill at the bottom of the wall.
- Fasten the base flashing to the wall with a waferhead screw through the upright 2" leg every 24" to 48"
- Install the first panel so the bottom is 1/16" to 1/8" from the base of the flashing.
- Subsequent panels are to be installed the same as the first, so that they are even and uniform.

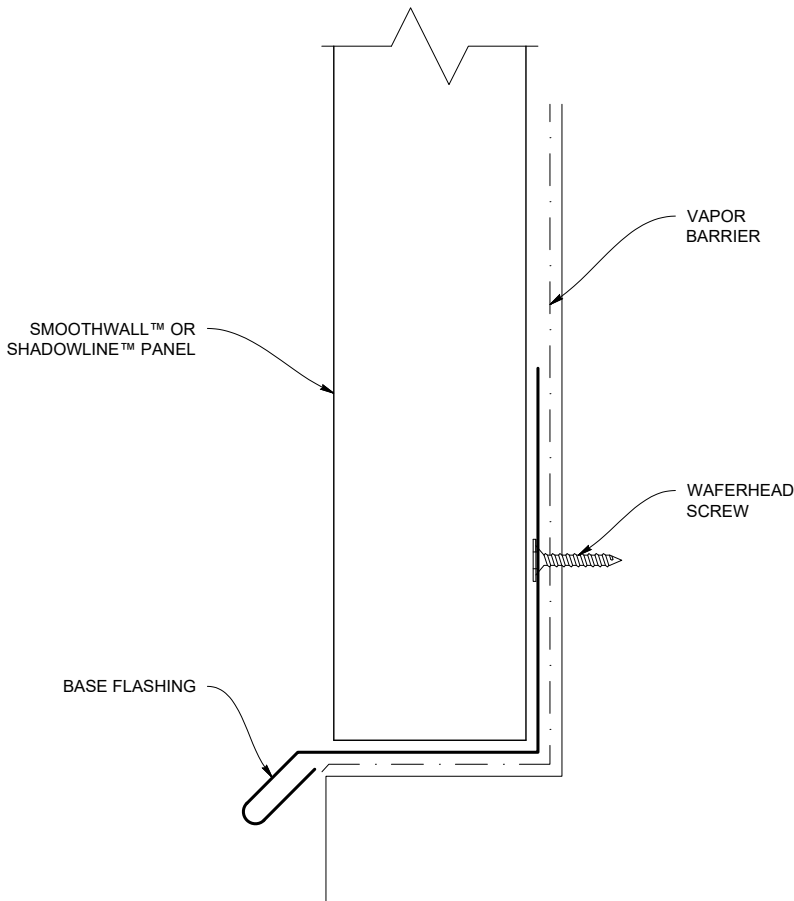

PART SHOWN: BASE FLASHING **(SW100BF / SH100BF)**

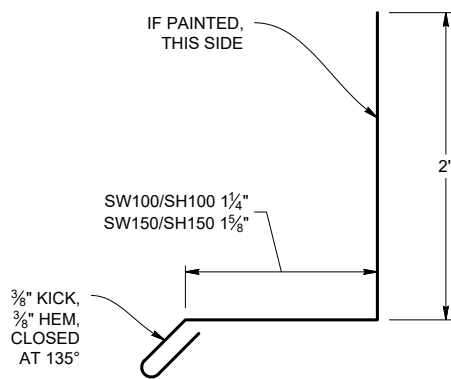

Outside Corner Flashing

TYPE A

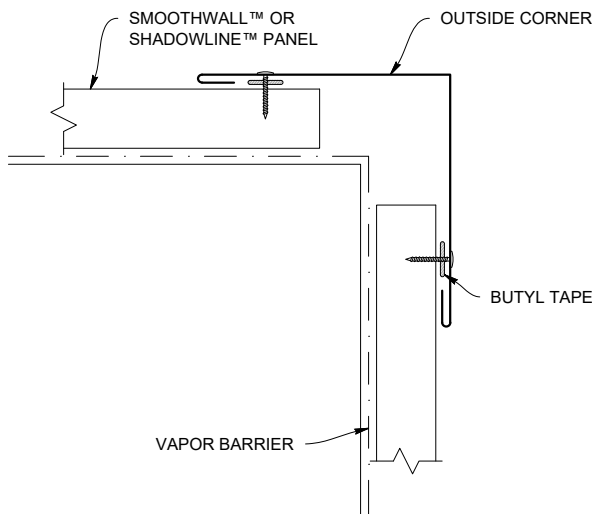

SmoothWall™ / ShadowLine™ Outside Corner Flashing Application

Type A:

- Install the panels on the wall, running the panels to the corner. Trim as necessary.
- Run a strip of butyl tape or caulking on the inside of the flashing, 1" in from each outside edge of the corner flashing.
- Attach the outside corner flashing to the panels with a rivet or a woodfast screw every 24" on both sides of the corner flashing, placing the fastener through the butyl tape.

TYPE B

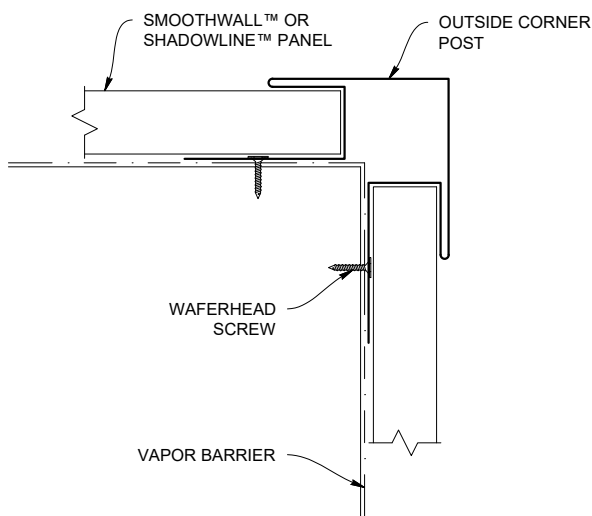

Type B:

- Install the outside corner flashing to the corner of the structure, using a waferhead type screw every 24". Fit the edges of the panels into the channel of the corner flashing.
- Revit the panels into place as needed.

PART SHOWN: TYPE A - SW100COA / SH100COA

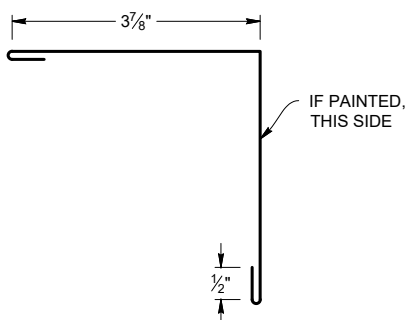

PART SHOWN: TYPE B - SW100COB / SH100COB

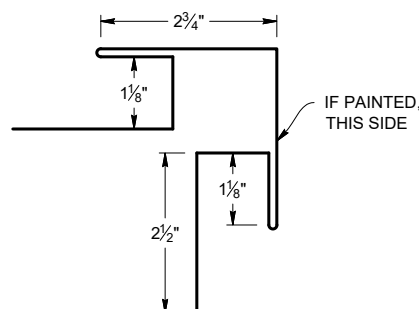

TYPE B - SW150COB / SH150COB

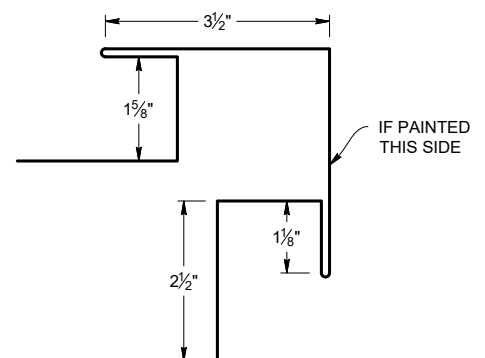

TYPE A

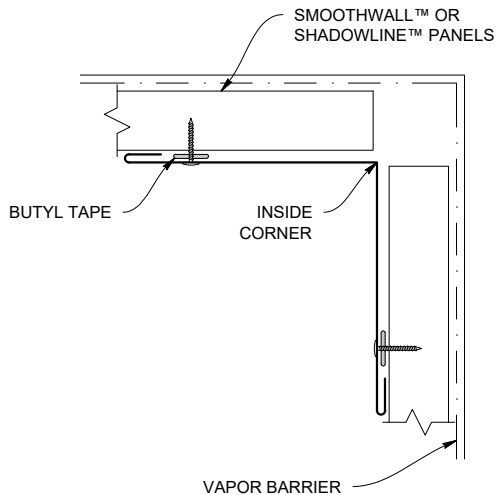

SmoothWall™/ ShadowLine™ Inside Corner Flashing Application

Type A:

- Install the panels on the wall, running the panels to the corner. Trim as necessary.
- Run a strip of butyl tape or caulking on the inside of the flashing, 1" in from each outside edge of the corner flashing.
- Attach the outside corner flashing to the panels with a rivet or a woodfast screw every 24" on both sides of the corner flashing, placing the fastener through the butyl tape.

TYPE B

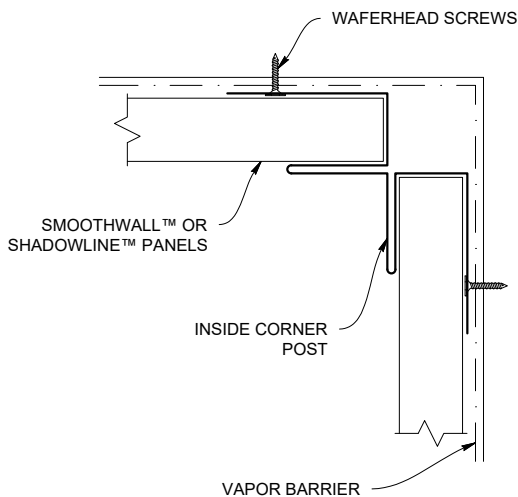

Type B:

- Install the inside corner flashing to the corner of the structure, using a waferhead type screw every 24". Fit the edges of the panels into the channel of the corner flashing.
- Revit the panels into place as needed.

PART SHOWN: TYPE A - SW100CIA / SH100CIA

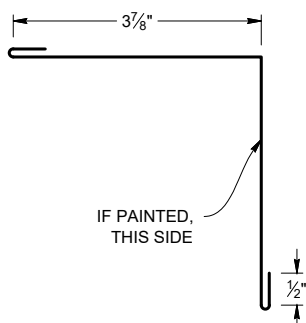

PART SHOWN: TYPE B - SW100CIB / SH100CIB

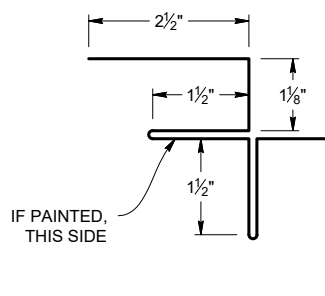

TYPE B - SW150CIB / SH150CIB

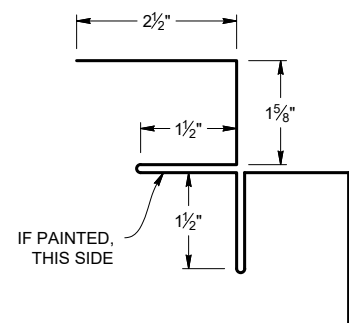

SmoothWall™/ ShadowLine™ Z-Flashing Application

- Install the Z-flashing by fastening it to the structure through the 2" leg with a waferhead screw every 24" to 48".
- Install the Z-flashing straight and square, perpendicular to panels and fasten into position.
- Install panels with C-Flashing and drip/sill flashing as previously stated.

PART SHOWN: Z-FLASHING
(SW100ZF / SH100ZF)

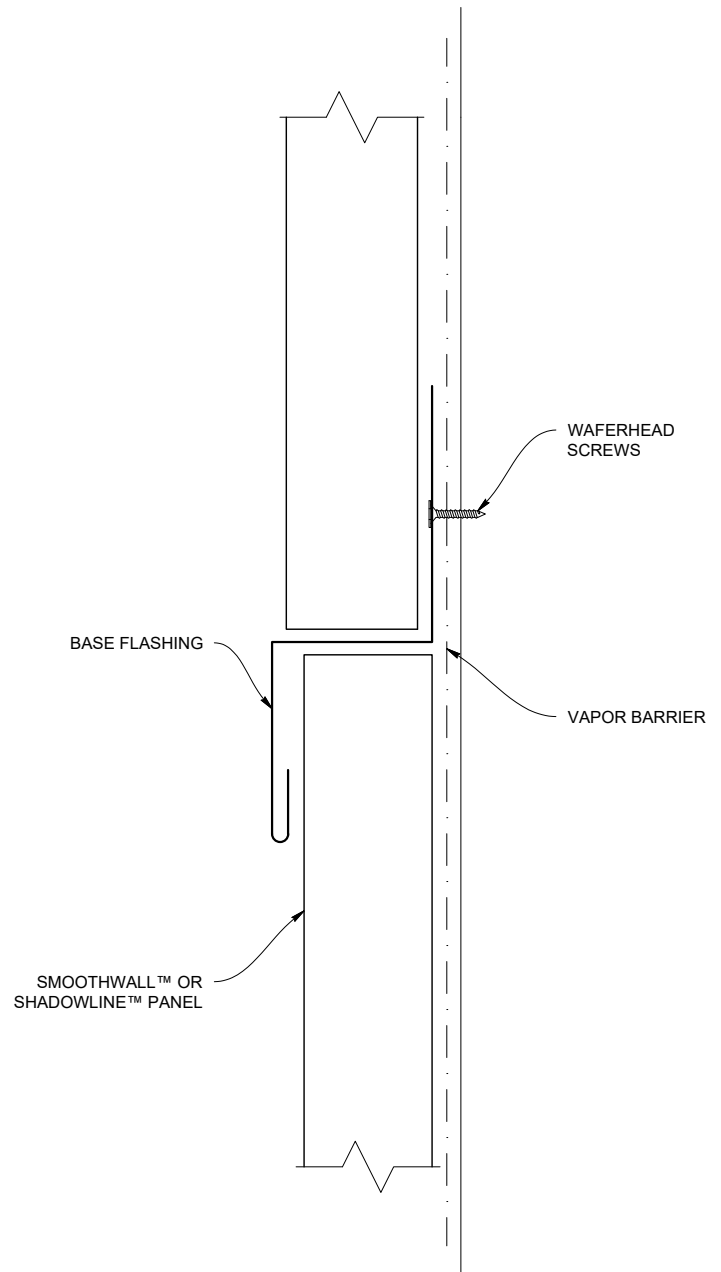
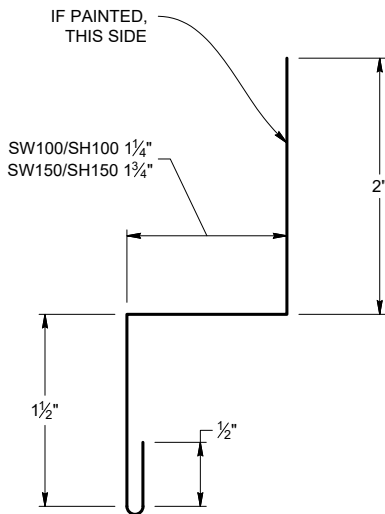

SmoothWall™ / ShadowLine™ Z-Backer Application

- Installation of Z-backer during panel installation creates a minor "pillowing" effect on the panel designed to mitigate Visual Canning Effects.
- Install flashing by pinning the top and bottom of Z-backer to surface before placing panel above.

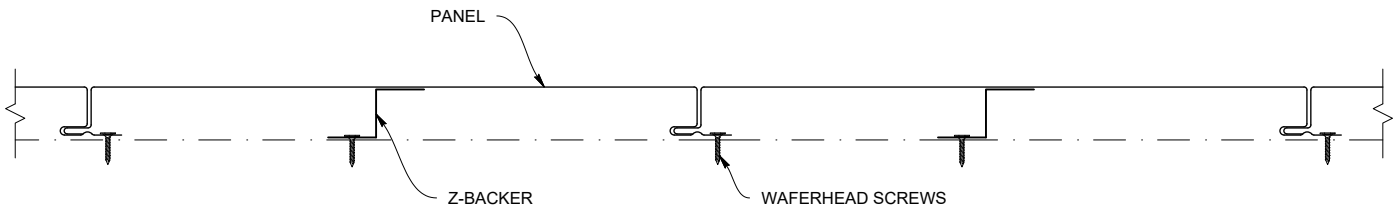

PART SHOWN: Z-BACKER
(SW100ZB / SH100ZB)

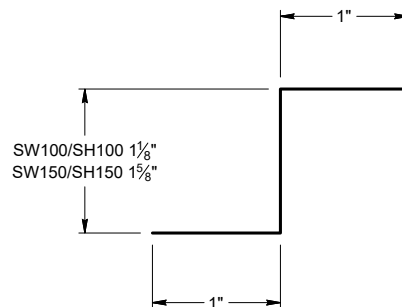

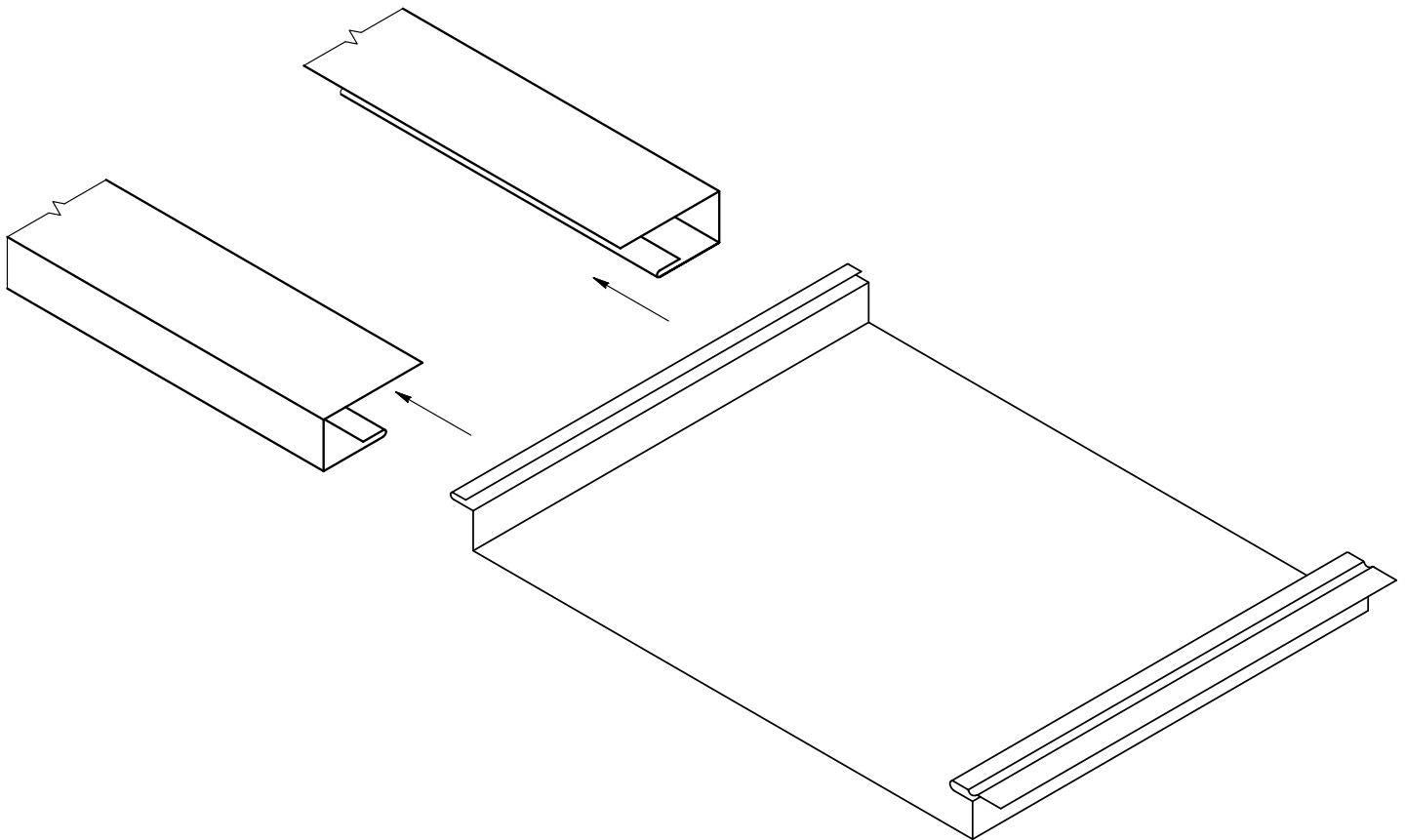

Lifetime Soffit™ Panel Installation

On a typical soffit installation, C-flashings are used on each side of the soffit (usually the building wall and the inside of the fascia board).

The panel is then inserted into the C-flashing from the end. Slide the panel to the end. The panel is fastened through the fastening flange of the panel to the structure, if the span exceeds 48". Fasten the panel to the C-flashing with a rivet on both fascia and wall sides.

Insert the next panel into the C-flashing and slide to meet the preceding panel. Fasten and repeat the process until the area is complete.

Lifetime Soffit™ C-Flashing Application

- The C-flashings are applied to the inside of the fascia board and directly across on the opposite wall, level with one another, and attached every 24" to 36" with a waferhead screw. Apply C-flashing on both sides and at each ends. For longer runs, it is usually better to apply 10' of flashing on each end at a time, that way you don't have to slide panels a great distance.
- Slide the soffit panels into the channel created by the C-flashing. The short leg of the panel should be pointed into the C-flashing at the start of the run. Be sure to fasten the panel to the structure if the span is greater than 48".
- Successive panels are installed the same way, but are installed so they attach to the previous panel. Push the panels together so there is little or no gab between them.
- Fasten each panel to the C-flashing with a rivet on both the fascia and wall sides as needed.
- C-flashing can be bent to allow the panels to be installed parallel with the roof line. The bend is limited to a 6/12 pitch or less. Specify pitch.

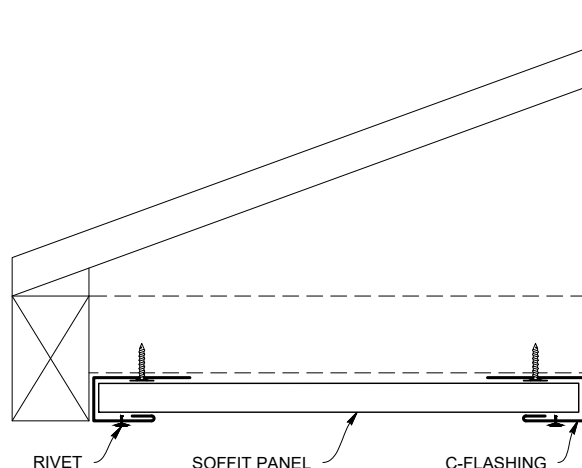

PART SHOWN: C-FLASHING
(SF100CF)

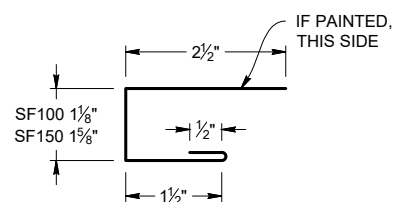

Lifetime Soffit™ Angle Flashing Application

- The Angle-flashing are applied both to the inside of the fascia board and directly across the opposite wall. The Angle-flashings are attached every 24" with a waferhead screw. Apply Angle-flashing on both the inside of the fascia board and the wall, as well as the end of the run.
- Lay each end of the panel(s) onto the ledge created by the 1-1/2" hemmed leg and fasten into place. Panels should be attached on each end to the Angle-flashing, on both the fascia and wall side. Be sure to support the panel if the span is greater than 48".

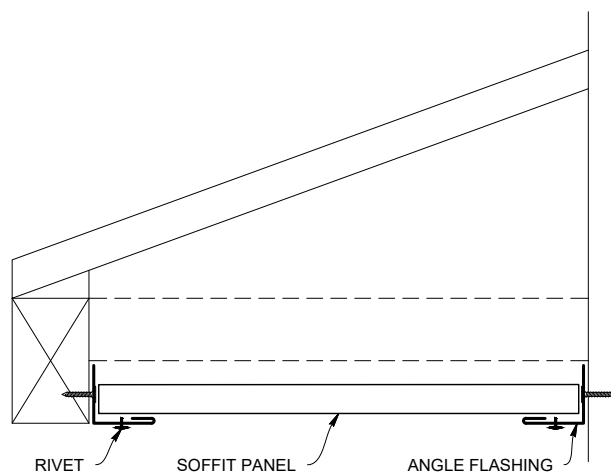

PART SHOWN: ANGLE FLASHING
(SF100FA)

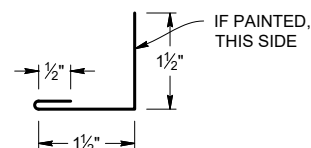

Lifetime Soffit™ Fascia Board Flashing Application

- This is a variation of the support flashings for the soffit panels. The Fascia Board flashing is used in conjunction with a fascia/wall panel, such as the SmoothWall™ Panel, and incorporates a ledge/leg to support the soffit panel.
- Installation of the soffit panels is the same as previously described.

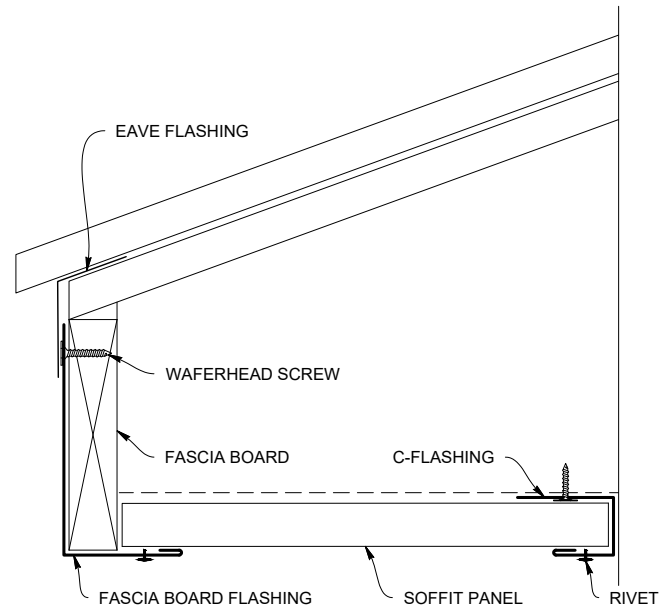

**PART SHOWN: FASCIA BOARD
(SF100FB)**

**PART SHOWN: C-FLASHING
(SF100CF)**

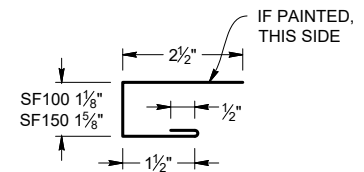
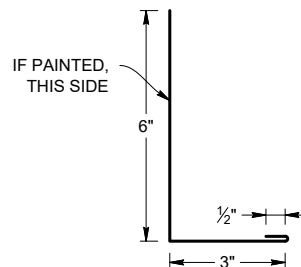

Lifetime Soffit™ H-Flashing Application

- Install the H-flashing by fastening the flashing to the structure through each of the long legs (2-1/2") with a waferhead screw.
- When installing panels at corners, cut the panels for the angle, usually 45 degrees, de-burr, clean and insert angled end into each side of the H-flashing.
- For long runs, install H-flashing straight and square perpendicular to panels and fasten into position. Install panels into channels at each end. Remember to fasten panel every 48" on single spans greater than 48".

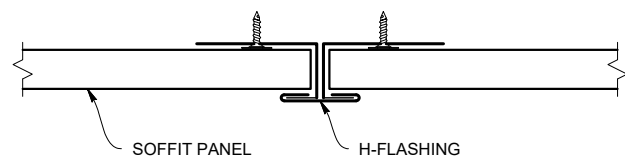

**PART SHOWN: H-FLASHING
(SF100HF)**

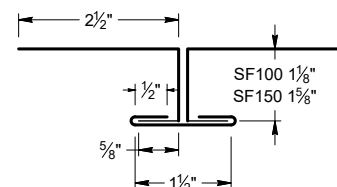

Lifetime Soffit™ Drip Flashing Application

- This is a variation of the support flashings for the soffit panels. The Soffit Drip flashing is used in conjunction with a fascia/wall panel, such as the SmoothWall™ Panel, and incorporates a drip lip as well as the ledge/leg to support the soffit panel.
- Installation of the soffit panels is the same as previously described.

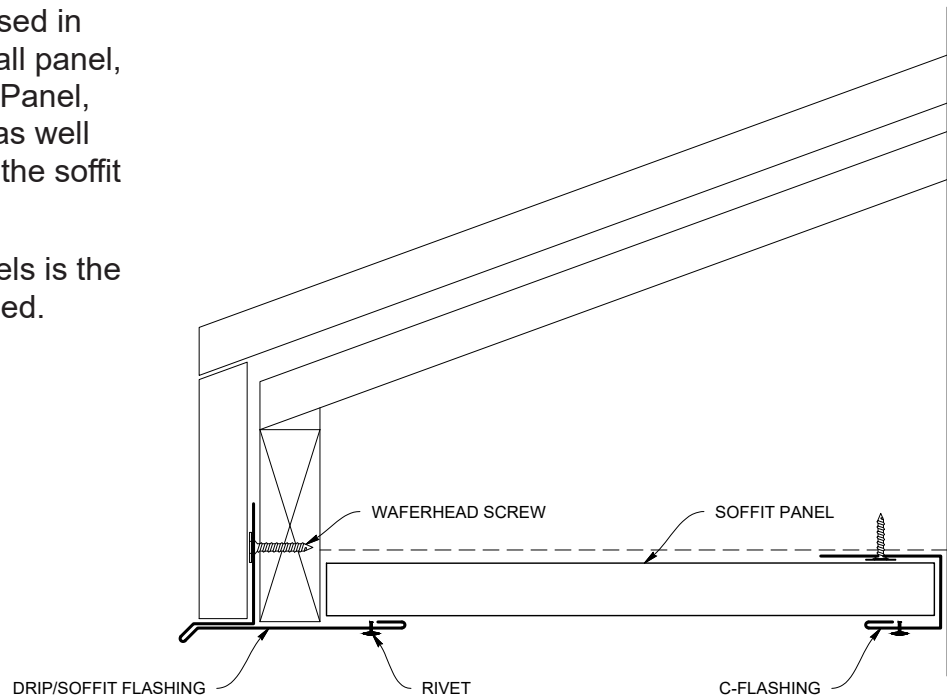

**PART SHOWN: DRIP FLASHING
(SF100DF)**

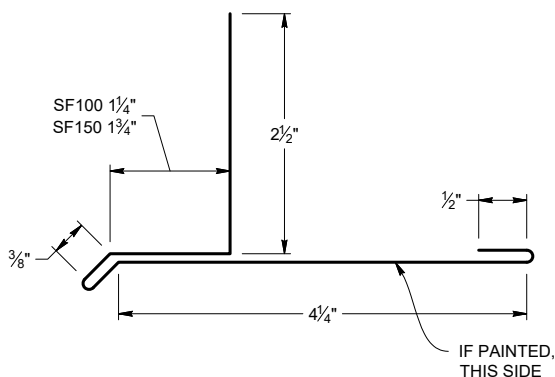

**PART SHOWN: C-FLASHING
(SF100CF)**

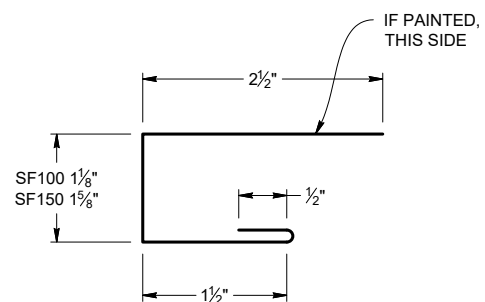

<p>SMOOTHWALL C-FLASHING SW100CF SW150CF</p> <p>WEIGHT: 4.78 LBS. S.O. SW100 - 5.625" SW150 - 6.125"</p> <p>PITCH: _____ SCALE: 1:2 PART LEN: 10'</p>	<p>SMOOTHWALL OUTSIDE CORNER TYPE A SW100COA SW150COA</p> <p>WEIGHT: 7.32 LBS. S.O. 8.75"</p> <p>PITCH: _____ SCALE: 1:2 PART LEN: 10'</p>
<p>SMOOTHWALL 1" ALT OUTSIDE CORNER TYPE B SW100COB</p> <p>WEIGHT: 12.40 LBS. S.O. 15"</p> <p>PITCH: _____ SCALE: 1:2 PART LEN: 10'</p>	<p>SMOOTHWALL 1-1/2" ALT OUTSIDE CORNER POST TYPE B SW150COB</p> <p>WEIGHT: 14.50 LBS. S.O. 17.5"</p> <p>PITCH: _____ SCALE: 1:2 PART LEN: 10'</p>

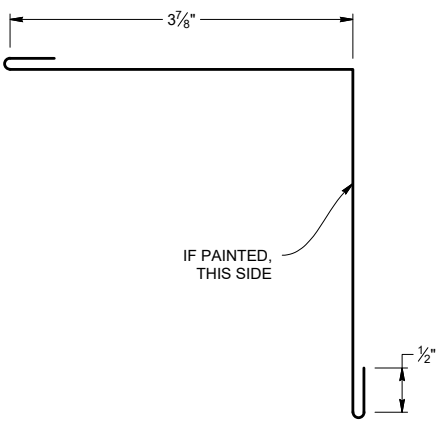
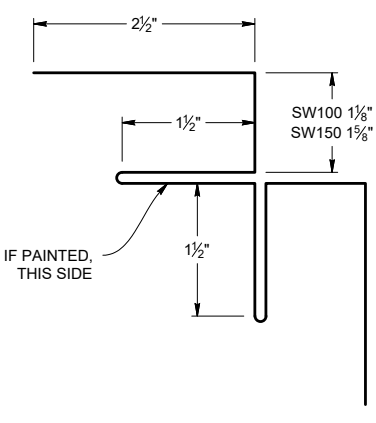
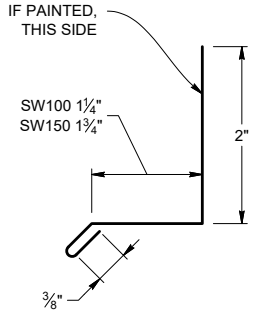
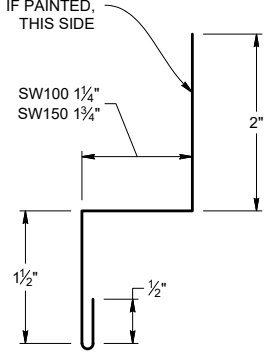
<p>SMOOTHWALL INSIDE CORNER TYPE A SW100CIA SW150CIA</p> <p>WEIGHT: 7.32 LBS. S.O. 8.75"</p>  <p>PITCH: _____ SCALE: 1:2</p> <p>PART LEN: 10'</p>	<p>SMOOTHWALL ALT INSIDE CORNER POST TYPE B SW100CIB SW150CIB</p> <p>WEIGHT: 10.98 LBS. S.O. SW100 - 13.25" SW150 - 14.25"</p>  <p>PITCH: _____ SCALE: 1:2</p> <p>PART LEN: 10'</p>
<p>SMOOTHWALL BASE FLASHING SW100BF SW150BF</p> <p>WEIGHT: 3.45 LBS. S.O. SW100 - 4" SW150 - 4.5"</p>  <p>PITCH: _____ SCALE: 1:2</p> <p>PART LEN: 10'</p>	<p>SMOOTHWALL Z-FLASHING SW100ZF SW150ZF</p> <p>WEIGHT: 4.47 LBS. S.O. SW100 - 5.25" SW150 - 5.75"</p>  <p>PITCH: _____ SCALE: 1:2</p> <p>PART LEN: 10'</p>

SmoothWall™ Flashing and Details Selection



SMOOTHWALL Z-BACKER

SW100ZB

SW150ZB

WEIGHT: 2.62 LBS.

S.O. SW100 - 3.125"

SW150 - 3.625"

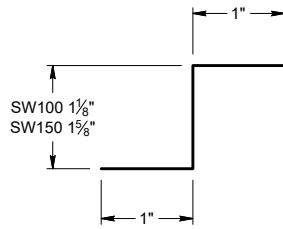

PITCH: _____

SCALE: 1:2

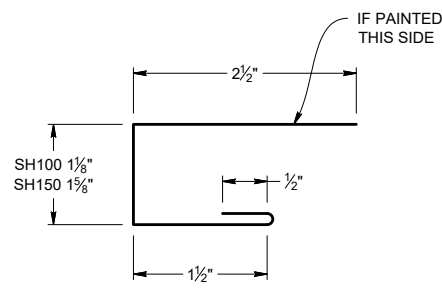
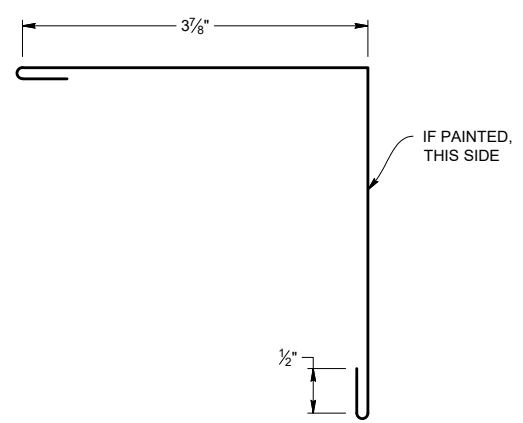
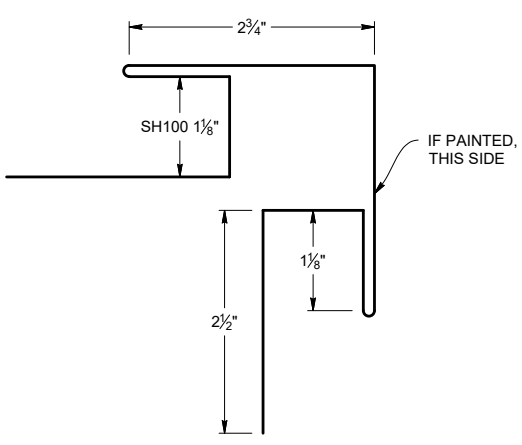
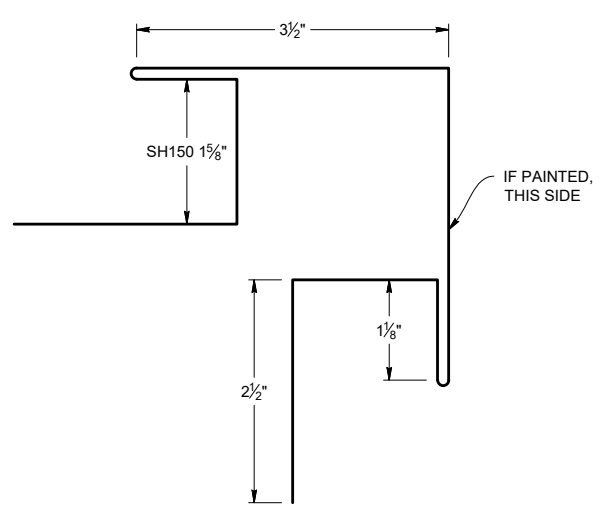
<p>SHADOWLINE C-FLASHING SH100CF SH150CF</p> <p>WEIGHT: 4.78 LBS. S.O. SH100 - 5.625" SH150 - 6.125"</p>  <p>PITCH: _____ SCALE: 1:2 PART LEN: 10'</p>	<p>SHADOWLINE OUTSIDE CORNER TYPE A SH100COA SH150COA</p> <p>WEIGHT: 7.32 LBS. S.O. 8.75"</p>  <p>PITCH: _____ SCALE: 1:2 PART LEN: 10'</p>
<p>SHADOWLINE 1" ALT OUTSIDE CORNER TYPE B SH100COB</p> <p>WEIGHT: 12.40 LBS. S.O. 15"</p>  <p>PITCH: _____ SCALE: 1:2 PART LEN: 10'</p>	<p>SHADOWLINE 1-1/2" ALT OUTSIDE CORNER POST TYPE B SH150COB</p> <p>WEIGHT: 14.50 LBS. S.O. 17.5"</p>  <p>PITCH: _____ SCALE: 1:2 PART LEN: 10'</p>

<p>SHADOWLINE INSIDE CORNER TYPE A SH100CIA SH150CIA</p> <p>WEIGHT: 7.32 LBS. S.O. 8.75"</p> <p>PITCH: _____ SCALE: 1:2</p> <p>PART LEN: 10'</p>	<p>SHADOWLINE ALT INSIDE CORNER POST TYPE B SH100CIB SH150CIB</p> <p>WEIGHT: 10.98 LBS. S.O. SH100 - 13.25" SH150 - 14.25"</p> <p>PITCH: _____ SCALE: 1:2</p> <p>PART LEN: 10'</p>
<p>SHADOWLINE BASE FLASHING SH100BF SH150BF</p> <p>WEIGHT: 3.45 LBS. S.O. SH100 - 4" SH150 - 4.5"</p> <p>PITCH: _____ SCALE: 1:2</p> <p>PART LEN: 10'</p>	<p>SHADOWLINE Z-FLASHING SH100ZF SH150ZF</p> <p>WEIGHT: 4.47 LBS. S.O. SH100 - 5.25" SH150 - 5.75"</p> <p>PITCH: _____ SCALE: 1:2</p> <p>PART LEN: 10'</p>

SHADOWLINE Z-BACKER

SH100ZB

SH150ZB

WEIGHT: 2.62 LBS.

S.O. SH100 - 3.125"

SH150 - 3.625"

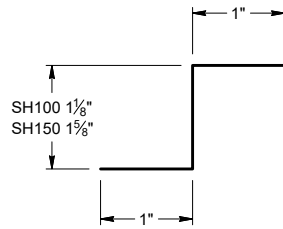

PITCH: _____

SCALE: 1:2

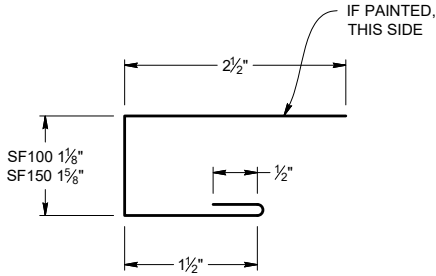
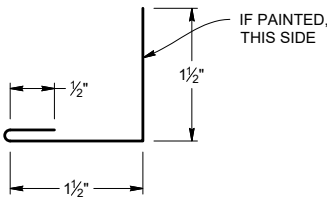
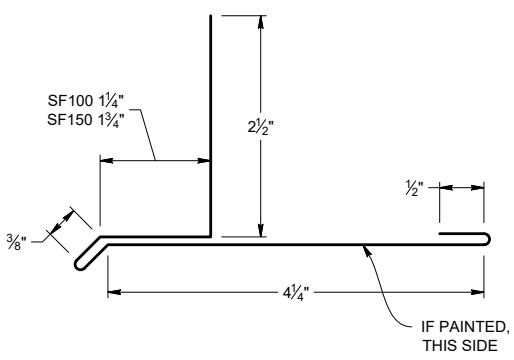
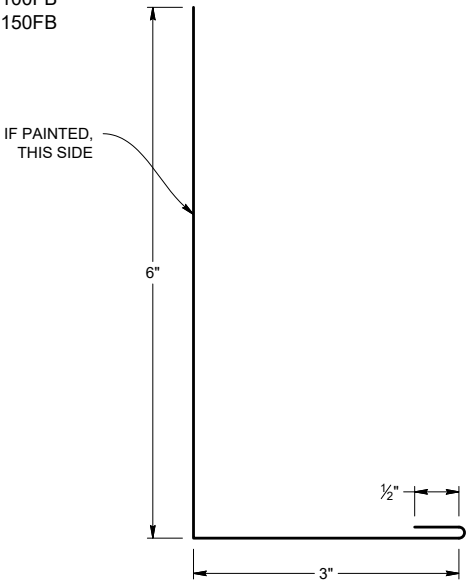
<p>SOFFIT C-FLASHING SF100CF SF150CF</p> <p>WEIGHT: 3.2 LBS. S.O. SF100 - 5.625" SF150 - 6.125"</p>  <p>PITCH: _____ SCALE: 1:2</p> <p>PART LEN: 10'</p>	<p>SOFFIT ANGLE FLASHING SF100FA SF150FA</p> <p>WEIGHT: 1.7 LBS. S.O. 3.5"</p>  <p>PITCH: _____ SCALE: 1:2</p> <p>PART LEN: 10'</p>
<p>SOFFIT DRIP FLASHING SF100DF SF150DF</p> <p>WEIGHT: 4.5 LBS. S.O. SF100 - 9.25" SF150 - 9.75"</p>  <p>PITCH: _____ SCALE: 1:2</p> <p>PART LEN: 10'</p>	<p>SOFFIT FASCIA BOARD SF100FB SF150FB</p> <p>WEIGHT: 4.6 LBS. S.O. 9.5"</p>  <p>PITCH: _____ SCALE: 1:2</p> <p>PART LEN: 10'</p>

SOFFIT H-FLASHING

SF100HF

SF150HF

WEIGHT: 5.3 LBS.

S.O. SF100 - 2x4.25" & 2.5"

SF150 - 2x4.75" & 2.5"

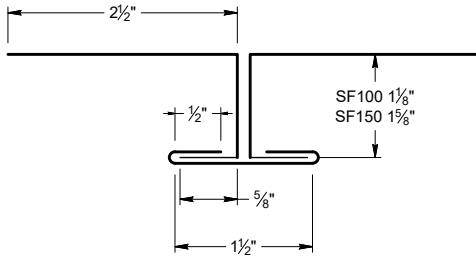

PITCH: _____

SCALE: 1:2

PART LEN: 10'

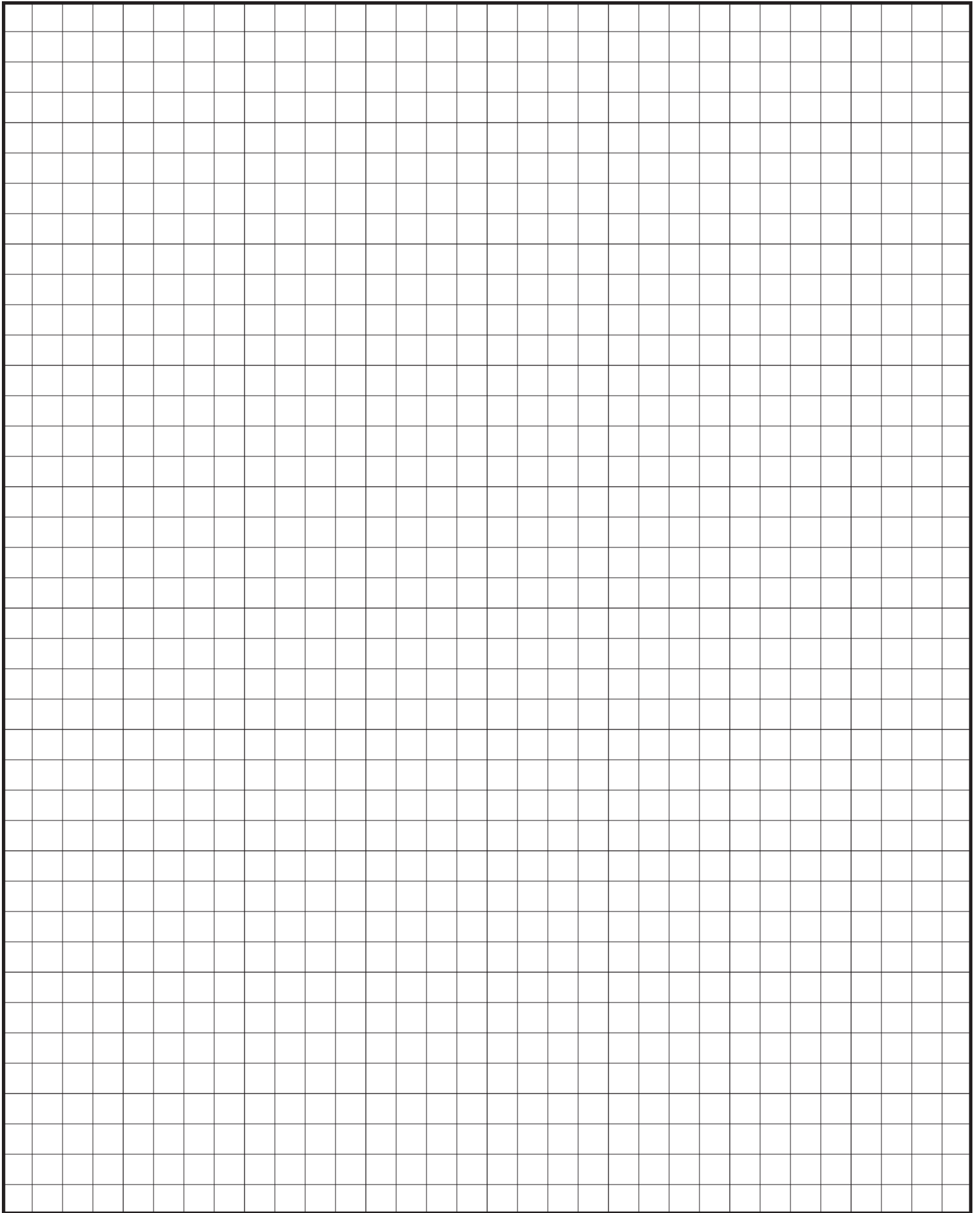



TAYLOR

METAL PRODUCTS

**QUALITY PRODUCTS
EXCEPTIONAL SERVICE**

SALEM BRANCH

4566 Ridge Dr. NE
Salem, OR 97301

Office: 503-581-8338
Toll Free: 1-800-574-1388
Fax: 503-581-6877

SACRAMENTO BRANCH

5711 Perrin Ave
McClellan, CA 95652

Office: 916-318-8844
Toll Free: 1-800-574-1388
Fax: 916-993-4123

SPOKANE BRANCH

1010 N Nelson St.,
Spokane, WA 99202
www.go-rsp.com

Office: 509-535-8667
Toll Free: 800-238-4057
Fax: 509-535-8682

AUBURN BRANCH

2601 C St. SW,
Auburn, WA 98001

Office: 206-900-9923
Toll Free: 1-800-574-1388
Fax: 253-804-3545

RIVERSIDE BRANCH

4880 Felspar St.
Riverside, CA 92509

Office: 323-407-7457
Toll Free: 1-877-504-1594