

STRIATIONS

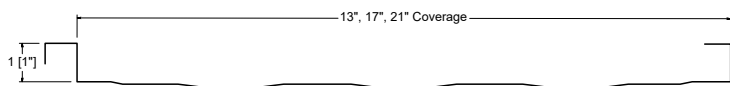

FLAT

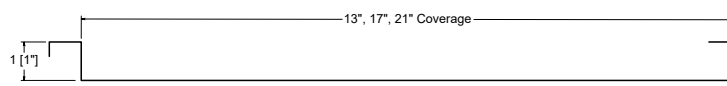

CLIP RELIEF

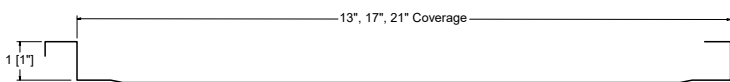

ACCENT RIBS

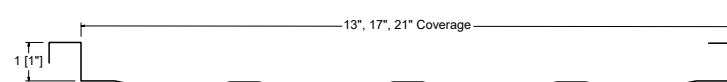

2 Accent ribs for 13" panels (Salem & Riverside)
3 Accent ribs for 17" & 21" panels
2 Accent ribs for all panels (Sacramento)

90° SEAM DETAIL

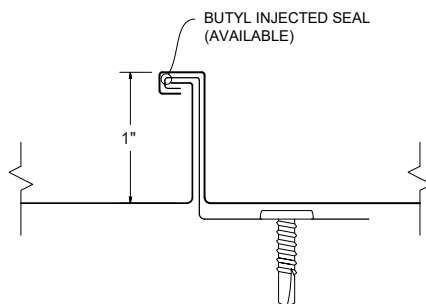

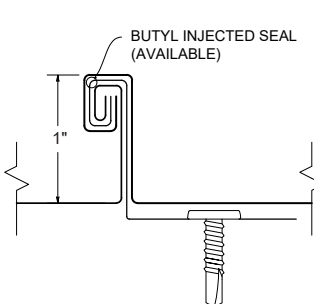

180° SEAM DETAIL



KEY FEATURES

- 13", 17" & 21" coverage options (*other widths inquire*)
- 24 & 22 Tru-Gauge™ and .032" Aluminum
- 16 & 20 oz. Copper (*Please inquire*)
- Zinc Coil (*inquire for thicknesses*)
- Floating clip system: allows for expansion/contraction of panels in longer lengths
- 1" vertical rib
- Factory injected Butyl sealant
- Clip Relief is not standard, available upon request
- Concealed fasteners: fasteners cannot leak
- 1:12 minimum pitch recommended (*For lower pitches, please inquire*)
- Standard panel lengths 3' to 60' - notched
Standard panel lengths 1' to 60' - not notched (*For longer panels, please inquire*)
- Onsite roll forming available
- Panel options: Striations, Accent Ribs, and Flat Pan
- Manufactured in Salem, OR and Riverside, CA

TESTING

-  ICC #5046 with CBC-CRC Supplement (Coming 2024)
-  Code compliance UL Evaluation Report UL ER #25913-01
- UL Construction No. 575 & 602
- UL 580 Class 90 - Wind Uplift
- UL 790 Class A (ASTM E108) - Fire rated
- UL 2218 Class 4 - Impact (hail) rated
- ASTM E1592 - Structural uniform static air pressure (Coming 2024)
- ASTM A653/A924 - G90 Galvanized
- ASTM A792 - Zinalume/Galvalume AZ-50/55
- ASTM B209 - Aluminum Substrate

WEIGHT CHART

MS-100	WIDTH	24 GA STEEL	22 GA STEEL	.032 ALUM
THICKNESS		0.0236"	0.0285"	0.032"
WEIGHT/LINFT	13"	1.284 LBS	1.550 LBS	0.608 LBS
WEIGHT/LSQFT	13"	1.185 LBS	1.431 LBS	0.561 LBS
WEIGHT/LINFT	17"	1.605 LBS	1.938 LBS	0.760 LBS
WEIGHT/LSQFT	17"	1.133 LBS	1.368 LBS	0.537 LBS
WEIGHT/LINFT	21"	1.926 LBS	2.325 LBS	0.912 LBS
WEIGHT/LSQFT	21"	1.100 LBS	1.329 LBS	0.521 LBS

ASTM E 1680/E283 Air Penetration	ASTM E 1646/E331 Water Penetration
25 PSF < 0.01 CFM/ft ² -PASS	50 PSF - Pass

Panel Clips

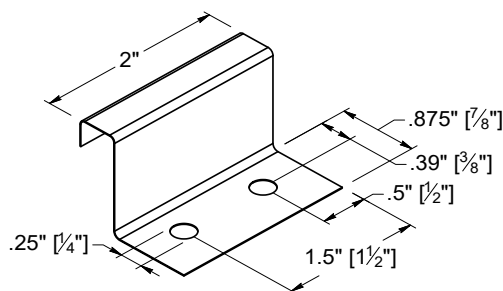
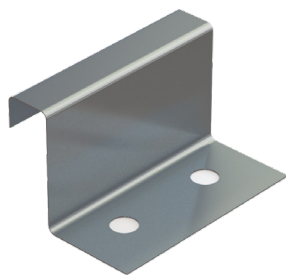

Clip Spacing

Panel clip spacing is based on structural design loads, engineered spanning capability of the panels and substrate.

Clips are fabricated from Grade 50 G90 base steel. The upper portion of the clip is 22ga thick, with a base of 16ga.

Floating clips will accommodate 1/2" and 1-1/4" of movement in both directions. This will allow the panel to easily expand and contract with thermal changes.

Contact TMP rep. for applications requiring allowances for more movement.

Fasteners

All fastener into steel and plywood must extend at least 3 full threads beyond the material. When attaching to dimensional lumber, 1" embedment is required.

90° Seam

OSB: #10 Burr Buster

Plywood and Dimensional Lumber:

#10 Screw 16ga (or less)

Steel deck:

#10 or #12 Screw with DP-1

180° Seam

OSB: #10 Burr Buster

Plywood and Dimensional Lumber:

#10 or #12 Screw

16ga (or less) Steel deck:

#14 Screw with DP-1

STANDARD CLIP: For UL rated non-engineered and solid deck applications

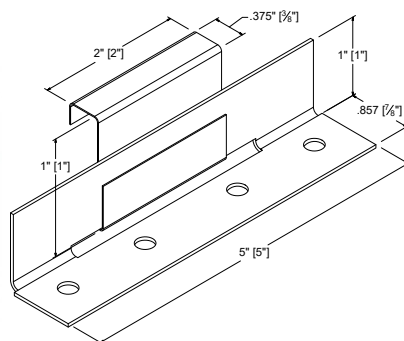
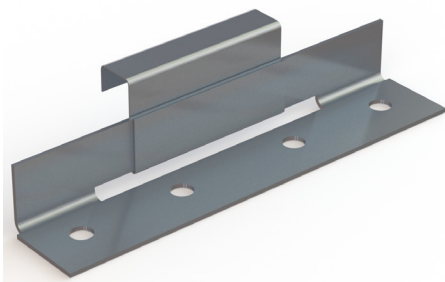

FLOATING CLIP: For UL rated non-engineered and solid deck applications. Will accommodate 1/2" of movement in both directions.

SINGLE LOCK NEGATIVE LOAD CHART

90° SEAM (SINGLE FOLD)

Width, in. Gauge Yield ksi Weight psf				SECTION PROPERTIES						ALLOWABLE UNIFORM LOADS, psf For various clip spacings (i.e. span values)					
				Top in Compression			Bottom in Compression			Negative Load					
				Ixx in4/ft.	Ixx (eff) in4/ft.	Sxx in3/ft	Ixx in4/ft.	Ixx (eff) in4/ft.	Sxx in3/ft	8"	1'	1.5'	2'	2.5'	3'
17	24	50	1.15	0.0219	0.0187	0.0246	0.0111	0.0142	0.0215	63.5	57.7	48.9	40.2	31.4	22.6
17	22	50	1.35	0.0261	0.0226	0.0296	0.0141	0.0176	0.0258	63.5	57.7	48.9	40.2	31.4	22.6

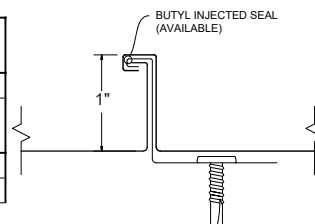

- Charted Load/Span values are based on ASTM E1592-02 / ASTM E1592-05 testing protocol
- Charted Allowable Uniform Loads are based on the Ultimate Uniform Load (per ASTM E1592-05 testing) divided by 2.00 Factor-of-Safety.
- Minimum recommended substrate (structure) recommendations:
 - o Open-framing (i.e.purlins) -16ga (design thickness=0.0566")
 - o Plywood/OSB - 15/32" or thicker is recommend to assure an effective degree of fastener thread engagement.
 - o Metal deck - 22 ga. (design thickness=0.0283")

SINGLE LOCK POSITIVE LOAD CHART

90° SEAM (SINGLE FOLD)

Width, in. Gauge Yield ksi Weight psf				SECTION PROPERTIES						ALLOWABLE UNIFORM LOADS, psf For various clip spacings (i.e. span values)									
				Top in Compression			Bottom in Compression			Positive Load									
				Ixx in4/ft.	Ixx (eff) in4/ft.	Sxx in3/ft	Ixx in4/ft.	Ixx (eff) in4/ft.	Sxx in3/ft	1'	2'	3'	4'	5'	6'	7'	8'	9'	10'
17	24	50	1.15	0.0219	0.0187	0.0246	0.0111	0.0142	0.0215	358.2	134.4	59.7	33.6	21.5	14.9	11.0			
17	22	50	1.35	0.0261	0.0226	0.0296	0.0141	0.0176	0.0258	330.9	161.3	71.7	40.3	25.8	17.9	13.2	10.1		
17	0.032"	19	0.378	0.0303	0.0303	0.0345	0.0303	0.0303	0.2680	17.9									
17	0.040"	19	0.435	0.3660	0.3660	0.0417	0.3660	0.3660	0.0319	27.0									

- Allowable loads for Steel panels are calculated in accordance with 2020 AISI S100 specifications considering bending, shear, combined bending and shear and deflection. Allowable load considers a 3 or more equal span condition.
- The Versa-Span Panel when installed as a three-span condition with spans of 5 ft. on-center for Steel and 3.0 ft.on-center for Aluminum are capable of withstanding the minimum uniform distributed load of 20 psf (0.958 kPa) noted in Table 1607.1 of the IBC and a minimum concentrated load of 300 lbf (1.33 kN).
- When panels are installed over solid or closely fitted deck sheathing, the capacity is limited to the capacity of the underlying sheathing.

DOUBLE LOCK NEGATIVE LOAD CHART

180° SEAM (DOUBLE FOLD)

SECTION PROPERTIES				ALLOWABLE UNIFORM LOADS, psf For various clip spacings (i.e. span values)												
				Top in Compression			Bottom in Compression			Negative Load						
				lxx in4/ft.	lxx (eff) in4/ft.	Sxx in3/ft	lxx in4/ft.	lxx (eff) in4/ft.	Sxx in3/ft	1'	1.5'	2'	2.5'	3'	3.5'	4'
Width, in.	Gauge	Yield ksi	Weight psf	0.0219	0.0187	0.0246	0.0111	0.0142	0.0215	130.0	114.4	98.8	83.2	67.6	52.0	36.4
17	24	50	1.15	0.0219	0.0187	0.0246	0.0111	0.0142	0.0215	130.0	114.4	98.8	83.2	67.6	52.0	36.4
17	22	50	1.35	0.0261	0.0226	0.0296	0.0141	0.0176	0.0258	130.0	114.4	98.8	83.2	67.6	52.0	36.4

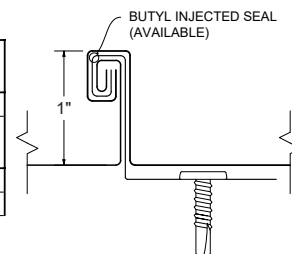

- Charted Load/Span values are based on ASTM E1592-02 / ASTM E1592-05 testing protocol
- Charted Allowable Uniform Loads are based on the Ultimate Uniform Load (per ASTM E1592-05 testing) divided by 2.00 Factor-of-Safety.
- Minimum recommended substrate (structure) recommendations:
 - o Open-framing (i.e.purlins) -16ga (design thickness=0.0566")
 - o Plywood/OSB - 15/32" or thicker is recommend to assure an effective degree of fastener thread engagement.
 - o Metal deck - 22 ga. (design thickness=0.0283")

DOUBLE LOCK POSITIVE LOAD CHART

180° SEAM (DOUBLE FOLD)

SECTION PROPERTIES				ALLOWABLE UNIFORM LOADS, psf For various clip spacings (i.e. span values)															
				Top in Compression			Bottom in Compression			Positive Load									
				lxx in4/ft.	lxx (eff) in4/ft.	Sxx in3/ft	lxx in4/ft.	lxx (eff) in4/ft.	Sxx in3/ft	1'	2'	3'	4'	5'	6'	7'	8'	9'	10'
Width, in.	Gauge	Yield ksi	Weight psf	0.0219	0.0187	0.0246	0.0111	0.0142	0.0215	358.2	134.4	59.7	33.6	21.5	14.9	11.0			
17	24	50	1.15	0.0219	0.0187	0.0246	0.0111	0.0142	0.0215	358.2	134.4	59.7	33.6	21.5	14.9	11.0			
17	22	50	1.35	0.0261	0.0226	0.0296	0.0141	0.0176	0.0258	330.9	161.3	71.7	40.3	25.8	17.9	13.2	10.1		
17	0.032"	19	0.378	0.0303	0.0303	0.0345	0.0303	0.0303	0.2680	17.9									
17	0.040"	19	0.435	0.3660	0.3660	0.0417	0.3660	0.3660	0.0319	27									

- Allowable loads for Steel panels are calculated in accordance with 2020 AISI S100 specifications considering bending, shear, combined bending and shear and deflection. Allowable load considers a 3 or more equal span condition.
- The Versa-Span Panel when installed as a three-span condition with spans of 5 ft. on-center for Steel and 3.0 ft.on-center for Aluminum are capable of withstanding the minimum uniform distributed load of 20 psf (0.958 kPa) noted in Table 1607.1 of the IBC and a minimum concentrated load of 300 lbf (1.33 kN).
- When panels are installed over solid or closely fitted deck sheathing, the capacity is limited to the capacity of the underlying sheathing.